

Wireless Weekly

Vol. 5.
No. 13

CONTENTS

A Nine Valve Super-Heterodyne Receiver.

Some Experiments with an Ultraudion Circuit.

H.F. Measurements of Coil Efficiency.

Experimenting on Five Metres. The Resistocap Unit.

Jottings by the Way, Random Technicalities, Valve Notes, A Coil Testing Stand, Correspondence, Information Department, Apparatus We Have Tested, etc., etc.



Making a Start in Transmission.

By PERCY W. HARRIS.

The noiseless Balkite Battery Charger

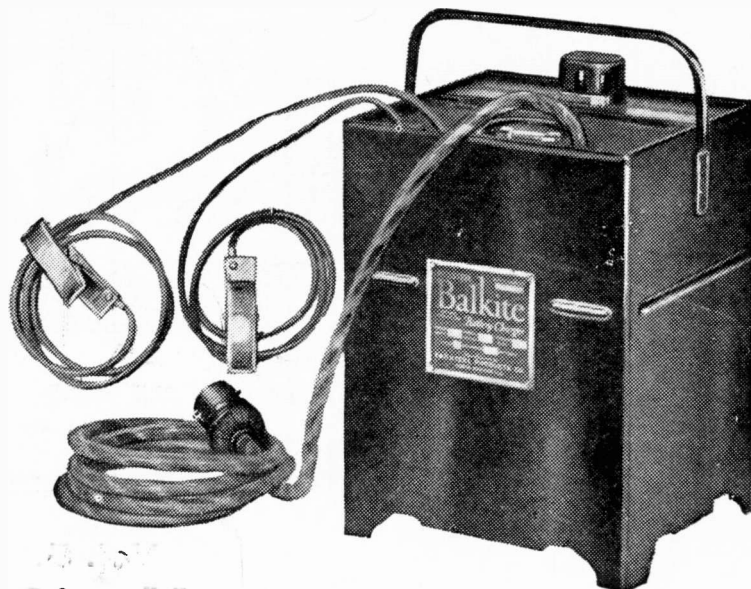

has no valves or moving parts

YOU would appreciate the convenience of being able to charge your wireless accumulator at home, and if your electric supply is 200-240 volt 50-60 cycle alternating current, the Balkite Battery Charger, a new Burndept accessory, will enable you to do so. The Balkite Charger is *absolutely noiseless* in operation and does not cause disturbances in any wireless receiver nearby. It is strong and simple, has no moving parts, vibrators or contact points, and there are no expensive valves to renew. There is nothing to adjust or get out of order. The Charger is designed in such a way that *both* half cycles of the alternating current are converted into the direct current for charging the accumulator. The charging rate being $2\frac{1}{2}$ to 3 amperes per hour, a 6-volt 50-ampere accumulator will be completely charged in about 20 hours at an average cost of $\frac{1}{2}$ d. per hour, based on a cost of 6d. per unit. An accumulator in regular use left once weekly to charge overnight will be full up in the morning. The Charger delivers a taper charge, and cannot discharge, short-circuit or damage the battery by overcharging. The appliance has an adapter for plugging into any lamp socket and two spring clips for connection to the accumulator. When filled with a quantity of ordinary accumulator acid and a little oil it is ready for use, and the only attention it requires is the periodical addition of a little distilled water. The rectifying cell contains a rare metal called Balkite, which is specially produced for use in the Charger. The Balkite Charger is robustly constructed and "fool-proof"—there is nothing better for the purpose of charging accumulators from electric light supply. Write for full particulars.

No. 491. Balkite Battery Charger, 200-240 volts, 50-60 cycles (alternating current), without acid or oil, £5 15s.

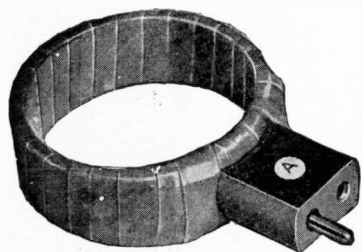

Full particulars of Burndept Coils, together with prices and interesting laboratory data, are included in Publication No. 44, a copy of which will be sent free on request.

Set of 4 Extra Short Wave Coils (80-150 metres) 16s.

Set of 4 Concert Coils (150-800 metres)... .. 16s.

Set of 9 Coils, £.5 to 1,000 (750-20,000 metres) £3 16s. 6d.

Prices of single Coils on application.

BURNDEPT COILS.—The use of highly efficient tuning coils is more than desirable in short-wave receivers—it is essential if good results are to be obtained. Burndept Coils have extremely low self-capacity and high-frequency resistance, because of the patented methods of winding, and are therefore most suitable for use in such instruments. The spring socket fittings are non-reversible and make perfect contact. The complete range of Burndept Coils covers all wave-lengths from 80 to 25,000 metres.

BURNDEPT

WIRELESS APPARATUS

BURNDEPT LTD., Aldine House, Redford Street, Strand, London, W.C.2

Telephone: Gerrard 9072.

Telegrams: Burndept, Westrand, London.

LEEDS: 12, Basinghall Street (near City Square).

CARDIFF: 67, Queen Street.

NORTHAMPTON: 10, The Drapery.



Wireless Weekly

Radio Press, Ltd.

BUSH HOUSE, STRAND, W.C.2.

Tel.—City 9911.

Assistant Editor:
PERCY W. HARRIS.

Scientific Adviser:
Prof. G. W. O. HOWES,
D.Sc., M.I.E.E.

Advisory Editors:
Prof. R. WHIDDINGTON,
M.A., D.Sc.
Prof. C. L. FORTESCUE,
M.A., M.I.E.E.

Staff Editors:

E. H. CHAPMAN,
M.A., D.Sc.

A. D. COWPER,
M.Sc.

R. W. HALLOWS,
M.A.

G. P. KENDALL,
B.Sc.

S. G. RATTEE,
Member I.R.E.

EDITED BY JOHN SCOTT-TAGGART, F.Inst.P.,
A.M.I.E.E.

Vol. 5, No. 13

JANUARY 14, 1925.

Price 6d. net.

Protecting the Public

DURING the last twelve months we have seen considerable progress towards an ideal which has always seemed to us highly important—the satisfaction of the customer in every wireless transaction. Much ground has yet to be traversed before this desirable ideal is attained, but no one can deny that the year 1924 showed really gratifying progress towards it.

Soon we shall look back to 1924 as the year when the valve manufacturers first realised that some steps should be taken to prevent use of a valve by unscrupulous people before delivery to the customer. Until that time it was quite possible for the small dealer who had no scruples in the matter to unpack his valves every night, use them in his own receiver, and put them back into stock next morning without the customer being any the wiser. By shielding himself behind the statement that "he could not be responsible for a valve after it had left the shop," he was frequently able to sell valves with burnt-out filaments.

By the end of the year two leading firms (joined within the last few weeks by a third) were selling their valves in special cartons, which allows a battery to be placed across the filament terminals so as to show that this is intact, while preventing the use of the valve in a wireless receiver. We hope it will not be long before every valve sold will be in some such packing.

Another matter established on a far better basis, so far as the satisfaction of the customer is concerned, is the sale of ebonite. We hope we shall be pardoned a feeling of satisfaction that Radio Press, Limited, has done more than any other body to secure for the public the sale of guaranteed ebonite,

free from the surface leakage which, before we commenced our campaign, was looked upon as an inevitable accompaniment of sheet ebonite. The methods adopted in manufacturing ebonite for general commercial purposes were, quite satisfactory years

ago, and we are surprised that manufacturers were so long in realising the changed conditions brought about by wireless. Every serious experimenter will confirm that in the last twelve months the quality of low-frequency intervalve transformers has been greatly improved. The low-frequency trans-

former is one of those components which, for some reason or other, is manufactured by all kinds and conditions of makers. It is a component which needs much skill in design, and which can be the source of an amount of distortion scarcely realised by those who have yet to hear how pure wireless reproduction can be. A receiving set made with the best modern transformers is incomparably better than any made a couple of years ago. While for purity of reproduction the resistance capacity method of coupling has yet to be excelled, it can be safely said that the leading makes of intervalve transformer give results barely distinguishable from those given by well-designed resistance-capacity coupling. We note with satisfaction, too, that the general public—even that section of it which has comparatively little to spend on wireless components—seems at last to be realising the futility of buying cheap and shoddy material of unknown make. Transformers, fixed condensers, gridleaks, and many other components must, so far as the average man is concerned, be bought "on trust"—that is to say, it is quite impossible to judge the quality from the exterior appearance, and often very difficult to ascertain exactly whether the component is faulty or not without an elaborate test. The Radio Press Service Department has tested many hundreds of readers' sets within the last twelve months, and in a large number of cases the fault has been due to some minor component, such as a gridleak or fixed condenser, of unknown make and most appalling inefficiency. Fortunately the number of such cases is rapidly decreasing, and we hope it will soon reach the zero point.

CONTENTS

	Page
Making a Start in Transmission ..	460
Jottings By The Way	464
A Useful Measuring Unit	466
The Resistocap Unit	471
Valve Notes	473
Your Lead-In	475
Some Experiments with an Ultraudion Receiver	476
Experimenting on 5 Metres	479
A "Super 5" and a Super- Heterodyne Receiver	482
A Coil Testing Stand	486
Valve Mounting for Experimental Work	487
Some Further Results Obtained with a "Two-Valve Receiver of Novel Design"	488
Correspondence	489
Apparatus We Have Tested	493
Information Department	495

Making a Start in Transmission

By PERCY W. HARRIS, Assistant Editor.

This is the first of a series of articles designed to be of assistance to the experimenter who has recently obtained his transmitting licence. As is always the case with articles by Mr. Harris, the information given will be of a practical nature and full constructional details for efficient low-power transmitting sets will be published.

Of course, if everybody started their wireless experiments in the proper way (they rarely do in receiving and never in transmitting) a very thorough theoretical study would be made of transmission, and after a long interval a series of carefully planned experiments would lead up to the first tentative experiment in transmission through the ether. Human nature being what it is, the man who has obtained a transmitting licence rushes up some kind of

dreary gramophone recitals which churn up the ether on Sunday mornings.

At the same time a very large amount of careful experimental work is being conducted, and while a great deal of theoretical matter has been published in relation to transmitting circuits, there appear to be comparatively few articles published on this side of the Atlantic giving information which every amateur transmitter needs.

The Start

In point of fact, the only safe way to start transmission experiments is some point midway between the two extremes we have indicated above. If too much attention is given to theory at the beginning there is always a danger that the experimenter will degenerate into the didactic type of person who is willing to prove to you quite conclusively that somebody else's circuit, which he has never tried, is far inferior to his own, which only exists on the back of an envelope. On the other hand, too little attention to theory generally means a great deal of wasted time and effort in trying out unworkable schemes and useless circuits.

A Trouble

The real trouble, of course, is where and how to begin. Here most text books and articles give you little guidance. A man has no right to call himself an experimenter if his sole work consists in making a Chinese copy of some friend's transmitter and in working it without meters or other means of obtaining precise information of its efficiency and general capabilities.

The only useful way to tackle the problem is to analyse a transmitting set to find what elements are common to every transmitter

and in some degree to standardise these so that general experimental work on old and new circuits can be carried out with a minimum of wasted effort, and the least possible expenditure of time, money and energy.

Efficiency

Amateur transmitters can be classified under two broad headings of "brute force merchants" and "efficiency experts." With the brute force merchants I have little sympathy. Many of them have no accurate measuring instruments, and achieve their

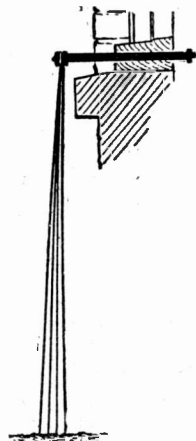

Fig. 1.—How the earth connection may be brought into the house to keep it clear of the wall.

circuit as quickly as he possibly can, and forthwith, using the full amount of power allowed by his permit (and a little bit more to make sure), calls up all and sundry and listens with great anxiety for his first QSL. If these first spasmodic attempts were followed by a more careful study of the various factors which go to make up successful transmission, there would be little complaint from the serious experimenter, but unfortunately a few of the amateur transmitters seem to be making little attempt at real experimenting, to judge by the alleged tests which are frequently carried out and long

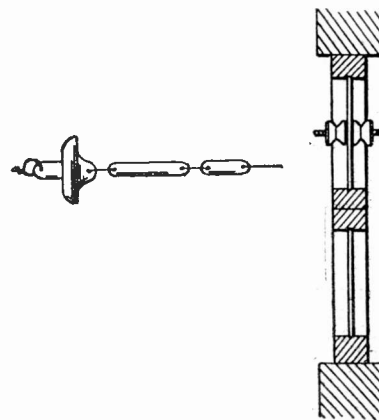

Fig. 2.—This diagram shows a good combination of insulators, and, on the right, a method of taking the lead-in through a pane of glass.

distance records (such as they are) by passing anything up to a kilowatt into their overloaded transmitting valve, thus getting into the aerial much energy, but with such low overall efficiency that they should be thoroughly ashamed of themselves. Few of them realise the sources of their power wastage, and would probably be staggered if the percentage ratio of output to input were measured and shown to them. It cannot be too fully realised that if we have

three different components in a transmitter, each of which is working at only 50 per cent. of its maximum efficiency, the working efficiency of the set may be 50 per cent. of 50 per cent. of 50 per cent., or, worked out as an overall efficiency, $12\frac{1}{2}$ per cent. If these three parts are working at only 25 per cent. of their possible maximum, then the overall efficiency will be about $1\frac{1}{2}$ per cent.!

The Better Way

The "efficiency experts" are much more interested in getting the maximum output for a given input than in merely piling up the aerial amperes without regard to how much is taken from the mains. As the great majority of amateur transmitters are licensed to use 10 watts only, the aim of these articles will be to show how to use this particular power efficiently, and I have no hesitation in saying that the distance possible to be covered by a well-designed 10-watt set is far greater than that obtained by many experimenters who habitually use over 100 watts.

Aerials

A great deal of nonsense has been written about aerials. It is all very well to say that the ideal aerial should be built in certain proportions, that there should be a minimum of this, and the other, that the site should be selected so as to be far away from buildings, trees, telegraph wires and other undesirable objects. Ninety-nine experimenters out of every hundred have got to put up the best aerial they can in a certain space available, and have little choice of site and surroundings.

First of all, then, it is only possible to say, put up the best aerial you can in your particular circumstances. For transmitting purposes it is as well to aim at height, and all parts of the aerial should, if possible, be kept well away from the house, 10 feet being a good minimum distance. Similarly, at the far end the aerial should not come too near the mast, if this latter has many stay wires attached to it.

Except for very short wavelength work, the single wire

aerial is not to be recommended. A twin aerial with the widest possible separation between the wires (not less than 4 or 5 feet), or a well made cage aerial, will generally give good results. Special precautions, too, must be taken in the matter of insulators. The voltages set up at the extreme end of the aerial are, of course, far higher in transmitting than in receiving, but it is not merely protection from a voltage breakdown that you need. A couple of good-sized shell insulators will stand all the voltage likely to be applied to the ends of

shell or egg type, place a number of these insulators in series, but if you have many of them the total weight will be greater than need be, and, in addition, a quite unnecessary strain will thus be imposed upon the aerial wire.

Stay Wires

If stay wires are used, these should be broken up by small insulators, although personally I consider that the losses generally attributed to the use of stay wires without insulators are, on wavelengths from 150 to 200 metres, grossly exaggerated. If you can

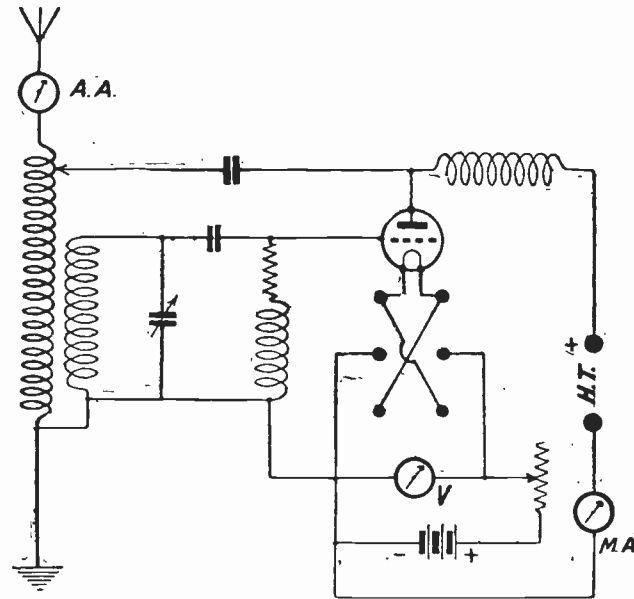

Fig. 3.—A typical transmitting circuit showing the positions of the meters.

an aerial using a 10 watt transmitter, but this is not to say that they are the kind of insulators recommended. These insulators may introduce very undesirable capacity leakages, for there is quite an appreciable capacity between the aerial wire and the supporting wire to which the insulator is attached. Long, thin porcelain rods (two or three in series) and a porcelain mushroom-shaped insulator forms a good combination which will stand voltage strain, and in addition will have a negligible capacity to earth.

Insulators in Series

Personally, at the moment, I am using the Everdry type of insulator behind a porcelain mushroom, and this seems quite satisfactory. As placing condensers in series reduces the capacity, you can, if you desire to use the

set up an unstayed mast satisfactorily, so much the better. If, as is so often the case, one end of the aerial is secured to a mast on the top of the house, be careful that no part of the aerial runs above the roof and close to it, or you will have a very low overall efficiency, so far as your aerial system is concerned.

Direct Earth or Counterpoise?

Although a consensus of opinion goes to show that the most efficient transmission is generally effected by the use of an aerial counterpoise, I do not recommend you to start off by erecting such a system. It is often useful to combine a counterpoise with a direct earth, and the majority of transmitting stations could probably be improved, so far as their earth connection is concerned. It is probably best,

first of all, to experiment and make yourself thoroughly conversant with the phenomena attending the use of a direct earth, making your earth connection as good and sound as possible and afterwards progressing from this to a counterpoise.

Earth Resistance

Very little direct measurement has been carried out on earth systems, owing to the difficulty of obtaining accurate comparative data. Personally, I favour a number of buried wires underneath the aerial, the distance below ground being but a few inches. This method of making an earth is probably less affected by weather changes than that in which an old galvanised bath or a sheet of zinc is buried beneath the window, and there is reason to believe that the dielectric losses are less.

Power Supply

It is quite a mistaken idea to imagine that efficient transmission can only take place when the experimenter has access to the electric lighting mains. In many districts, of course, there is no electric lighting supply. We need both high- and low-tension current. For lighting the filament of the valve of a 10 watt C.W. transmitter, an accumulator of the size you are accustomed to use with your receiver will do quite well, for the low power transmitting valve takes an ampere or an ampere and a half, at the most, while excellent transmission can be effected on powers well over 10 watts, using a valve of the L.S.5 type, which consumes less than 1 ampere. The high-tension supply is always the biggest problem.

High Tension

If we are using, for example, as our 10 watt input, a plate-current of 20 milliamps at a pressure of 500 volts, we cannot very well use dry cells, for the cost (both the first cost and the running expense) would be prohibitive. A high-tension accumulator, besides presenting difficulty in charging, costs, in the smallest practical size for this voltage, at least £25, and when of this size is certainly a nuisance to

look after. If we have direct current in the house this will give us, at the most, 250 volts and frequently only 100 volts; and if we have alternating current, while we can step up the voltage to any figure we like, we shall need rectifying and smoothing apparatus before it can be efficiently used.

Smoothing

Many experimenters beginning their transmission work are surprised when they find that the cost of rectifying and smoothing apparatus is quite considerable, and the mere possession of A.C. mains does not mean that one can start transmission for the expenditure of but a few shillings. In a later article we shall deal with the question of how best to use the A.C. mains, and meanwhile I will confine myself to the case of the man who wishes to begin some experiments and has no electric mains available.

I can only assume for the moment that he does not wish to



Fig. 4.—A combination of insulators.

instal a generating plant with his own dynamo.

Entirely from Low-Tension Accumulators

Fortunately it is now possible to build and run a thoroughly efficient 10 watt transmitter with low-tension accumulators as the sole source of power. In a subsequent issue I shall give complete constructional details of such a set now being operated at my own station, 2MQ. Before dealing in detail with this set, however, there are one or two other basic points on which I would like to dwell this week, and which are of considerable importance in whatever kind of set you build.

The Wavemeter

The first essential in every transmitting station, if really serious work is to be conducted, is a calibrated transmitting wavemeter. Such a wavemeter is

easy to build and not too expensive. You will find the full constructional details for such a wavemeter in *Wireless Weekly* for October 29, 1924, page 48. The cost, if you have none of the parts to start with, will be a little over £5. Much unnecessary use of the ether is caused by experimenters calling up their friends and asking them what is their wavelength, a totally unnecessary procedure if a transmitting wavemeter is in the station itself.

Other Meters

There are three other meters essential in every well-conducted transmitting station. They are not cheap, but you *must* have them if you are to do any accurate work with your set. They are, an aerial ammeter, a plate milliammeter and a filament voltmeter. Good scales for these instruments are 0 to .5 or 1 for the aerial ammeter, 0 to 100 for the plate milliammeter and 0 to 10 for the filament voltmeter. The few pounds you spend on these instruments at the beginning will bring an excellent return, and so far as the filament voltmeter is concerned, you will probably save its cost by the increased life of the valve, obtainable by its use.

Aerial Ammeters

There are two general types of aerial ammeter available. They are the hot wire ammeter and the thermo-couple ammeter, or thermo-ammeter, as it is generally called. Do not make the mistake, whichever type you buy, of ordering an instrument with too big a scale. An instrument reading up to, say, 1½ amperes maximum will have rather a congested scale at the bottom, just where you want to make the most accurate observation. The hot wire ammeter depends for its action upon the expansion of a very thin piece of wire which heats up with the aerial current. By means of a spring and lever the needle is deflected in varying degrees by the varied expansion.

A Fault

The trouble about hot wire ammeters is that they have constantly to be adjusted, for the

zero points are very sluggish in action and susceptible to temperature changes. The thermo-ammeter depends for its action on the minute current set up at the junction of two dissimilar metals. Thermo-ammeters are much quicker in their response, and have certain other virtues.

There are points for and against both types, but this is not the place to enter into arguments about them. I have one of each type and I certainly prefer the thermo-ammeter.

A Voltmeter Point

If you light your valve filament from an accumulator, an ordinary filament voltmeter will serve. If, however, your valve filament is lit from A.C., as is so frequently recommended, the voltmeter will have to be an A.C. instrument. Strangely enough, this point is rarely made in books and articles on transmission, which leads me to think that comparatively few people are using these instruments in their work. They are, of course, obtainable commercially.

Use of A.C. for Filament Lighting

If we consider the filament of a transmitting valve, it will be clear to us that the whole of the plate current has to pass from the filament across the vacuum space. For reasons which will probably be obvious to most readers of this article, the emission is greater at the negative end of the filament than at the positive, there being a gradual increase of emission from the positive end to the negative end. The filament will generally burn out at the end where there is the maximum emission, and as with alternating current the filament is alternately positive and negative at each end, the wear is equalised. For this reason the lighting of valves by alternating current is generally recommended.

Personally, I have devised a little scheme by which the life of the valve, when lit from D.C., is increased, but I do not know that it has ever been put forward before. It merely consists in inserting a reversing switch between the accumulator and the filament, as shown in Fig. 3. If we wire up a set in this way and make a

point each evening when we begin transmitting, of reversing the filament, it will be alternately positive and negative at each end and the wear will be correspondingly equalised. In this way the life of the valve is much increased.

Variable Condensers in Transmission

Owing to the high potentials induced in a transmitting set, the ordinary receiving variable condensers are rarely suitable, and I notice that one or two firms here (and several in the United States) are marketing special variable condensers for transmission purposes. They are, of course, rather expensive, as might be imagined. A scheme I am using and which I have not published elsewhere, is to use ordinary receiving condensers in series with high-grade fixed condensers of a value of $.002 \mu\text{F}$ or more. In this way if we place in series with a $.0005$ variable condenser of the ordinary receiving type a $.002$ fixed condenser (such as the Dubilier type 577, which will stand 1,000 volts without breakdown and has very low, almost negligible losses) the total capacity will be at a maximum round about $.0004 \mu\text{F}$, and the minimum will be slightly less than otherwise would be the case. Condensers, say, of the

Mansbridge type are hopeless for such a purpose, as not only are they liable to breakdown and consequent damage to the apparatus, but their losses are high when used in high-frequency circuits. This is no reflection on these condensers, as they are not designed for use in this way.

Gridleaks

In practically all transmitting circuits we need a gridleak. The ordinary type of receiving gridleak is quite useless in even a 10-watt transmitter, as, not only is its resistance too high, but it will not carry the current necessary. Good wire wound gridleaks are not cheap, but on the other hand they are less expensive than many experimenters imagine and can be obtained to carry current of 50 milliamperes or over without heating. This current is far higher than they would ever be called upon to carry in a 10-watt transmitter.

Temporary variable gridleaks, which are quite useful, are often devised by experimenters from jars containing liquid. A good value for a transmitting gridleak, if you are purchasing one, is 15,000 or 20,000 ohms tapped at a few points.

(To be continued.)



Patients in a ward at St. Bartholomew's Hospital listening to a programme from 2LO. A description of the set which was presented to "Barts" was given in "Wireless Weekly," Vol. 2, No. 9.



JOTTINGS BY THE WAY By Wireless Wayfarer

A Coincidence

A CORRESPONDENT whose achievements as an experimenter have secured him immediate election as honorary vice-president of the Little Puddleton Wireless Club sends

round until they are giddy and then delivers them upside down to T₂. By means of the second transformer T₃T₄, the detonated output, which, it should be remembered, is now in Esperanto, is led to V₂, which functions as

first half cycle of the incoming oscillation has a value O. This raises the flow of anode current to a value which is also O. The succeeding half cycle, whose value is L, further raises the anode current until it reaches E. The M crest of the next half cycle lowers it to N, and as the O of the final half cycle is not required the plate current drops immediately to a zero value. It is essential that a very bright four-electrode valve should be used for V₂. Valves provided with coated filaments are so dull that they never seem to get the hang of things properly, and they frequently give rise to a horrible form of distortion by rectifying into Cockney or Scotch.

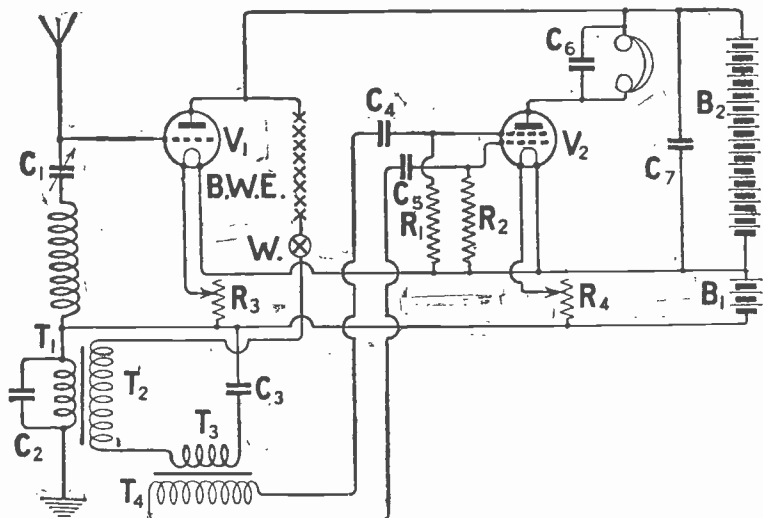

The theoretical circuit diagram of the "Hypiodine."

me to-day an account of a new circuit upon which he is at present engaged. This he has aptly named the "Hypiodine." The circuit is shown in the diagram above. Its particular purpose is to convert the transmissions of German broadcasting stations into human speech. The main principle of the circuit is that the output of V₁ is returned backwards to the valve by reflexing so that it detonates the input and turns German into Esperanto. Between the plate of V₁ and the first L.F. transformer T₁T₂ is a barbed-wire entanglement B.W.E., which offers a practically infinite impedance to gutturals. Next comes the Whizzer W., constructed after the manner of the railway turntable and the joy-wheel, which whirls electrons

a bi-lingual rectifier in the ordinary way and transforms the Esperanto oscillations applied to its grids into English and delivers them in amplified form to the telephones. Fig. 2 will give a clear idea of the working of the bi-lingual rectifier.

The Theory

Let us trace as an example the course of the German word *Feder* through the Hypiodine. After passing through V₁ it becomes in its detonated form the Esperanto *plumo*. In this form it reaches the double grid of the bi-lingual rectifier V₂. Incoming oscillations take the shape of the lower curve in Fig. 2 (the one which looks like an eel doing physical jerks to make the spine supple). It will be seen that the

Foreign Made Valves

On no account should foreign-made valves be employed for the purpose. One that I purchased cheaply, but a short time ago, turned everything into double

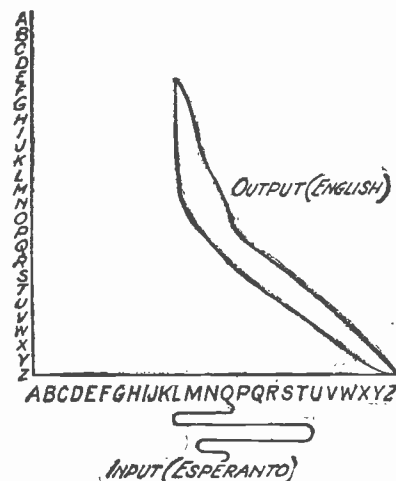

The characteristic curves of the bi-lingual rectifier.

Dutch. It should be noted that the Hypiodine circuit if properly adjusted may also be used for rectifying the broadcasts of Mr.

John Henry, whilst a special deodorising attachment may be added to remove the staleness of the jests made by members of concert parties.

Great Minds

It has often been said that great minds think alike, and here we have a curious instance of the truth of this dictum. At the very moment when the postman delivered my correspondent's letter Professor Goop and I were engaged in experimenting on a circuit upon almost identical lines. I was all for calling it the "Planetodyne," planetes being Greek for a wayfarer; but the Professor pointed out that this would never do since all self-respecting wireless terms are pure bred, hybrids borrowing their component parts from at least two of the dead languages. We therefore decided to name it the

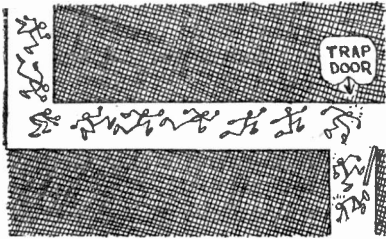

The principle of the Goop-Wayfarer Electron-Reverser.

Reversodyne, a name which satisfies the requirements of even the most exacting terminological purist. Our circuit differs in two important ways from the Hypoiodine. In the first place, instead of the cumbrous barbed-wire entanglement, which is very apt to mar reception by its scratchiness, we employ a medico-frequency choke which has the effect of throttling the undesired gutturals.

The Electron Reverser

Then again, we do not like the whizzer principle, for if electrons become giddy the stability of the set is liable to be affected. The device which we use is the Goop Wayfarer Electron-reverser, the principle of which is shown above. Electrons are led in the ordinary way through nice comfortable wires until thinking that all is clear they acquire high speed. At this point there is a sharp corner in the wire round which they rush with the utmost gaiety, only to find themselves confronted with an impassable barrier. Their attention is so

riveted on this and to their efforts to apply the brake that they do not notice the trapdoor, through which they fall. They are thus reversed and delivered



... Convert German into human speech ...

backwards and unharmed, save perhaps that they are a little out of breath, to T2. Their descent through the Goop-Wayfarer trapdoor and their subsequent fall curtails their high spirits, and so damps their ardour that the set is perfectly stable.

The Valve Question

The valve question in either the Reversodyne or the Hypoiodine is an exceedingly important one, and if it does not receive due attention a very distressing form of distortion will result. Ordinary valves as received from makers arrive in an exhausted state which renders them very liable to make serious grammatical mistakes whether they are employed as reflexing detonators or as bi-lingual rectifiers. The anode, too, suffers severely during the process of bombardment.

Special Manufacturing Processes

As previously mentioned, the Professor and I have shown that no valve can function properly in the state of exhaustion produced by a hard vacuum. Could you translate German on an empty



... Rectifying into Scotch ...

stomach? Our special valves do not contain an aching void; on the contrary they are filled with a mixture consisting of equal parts of oxygen and vitamins which enables them to stand up well to their work. A little powdered ginger may be added from time to time should the valve show signs of fatigue. Nor again are the

anodes subjected to the brutal process of bombardment. Instead of this they are talked through (did I mention that they were hat-shaped?) for long periods by ex-announcers of the B.B.C. specially retained by manufacturers on account of the purity of their diction and of the grammatical perfection of their speech. So high is the standard set that any "plate talker," as they are called, who is detected splitting an infinitive or saying "between you and I" more than twice in one day is immediately dismissed with ignominy.

The Results Obtained

I am, as you know, the most modest of men, and I never like to claim too much for the wonderful circuits that Professor Goop and I are continually giving to the world. I think, however, that I can claim that the Reversodyne is



... Could you translate German on an empty stomach? ...

about to revolutionise the reception of Continental broadcasting. So far we have been able to receive detonated and rectified transmissions from every Continental station with the exception of those situated in Czecho-Slovakia and Jugo-Slavia. We have not been able to discover a bi-lingual rectifier stout enough to deal with the combinations of consonants of which the languages of those parts are mainly composed. However, we are not yet defeated, and a special valve with cast-iron grid and six-inch armour plated anode is being made up for us by a well-known firm. With this we trust to be able to cope with any European tongue.

WIRELESS WAYFARER.

The R.S.G.B.

An Informal Meeting will be held at the Institution of Electrical Engineers, Savoy Place, S.W.1. at 6 p.m. on Wednesday, January 14, when Mr. Stanley Ward will give a talk on "Short Wave Reception."

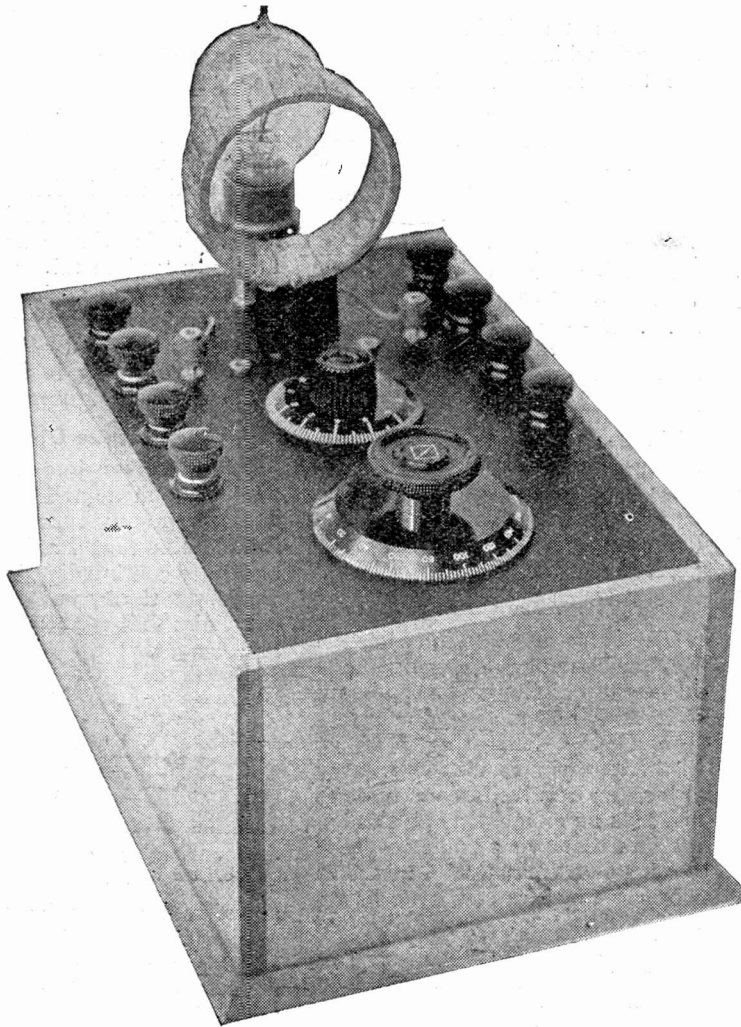

A graduated dial upon the filament rheostat is a desirable refinement.

THOSE of my readers who may be new to experimental work involving the accurate observation or measurement of results are not likely to have realised that one of the most important aids to accuracy and speed in carrying out such work is the provision of such apparatus and appliances as will render the whole experiment as easy as possible to perform. As a matter of fact, the man who experiments in a careless and untidy fashion is always under a severe handicap as compared with the man who spends a good deal of time upon preliminary work, laying out a convenient set of apparatus, arranging his measuring instruments so that they shall be easily read, and so forth, because when the latter class of worker actu-

ally commences upon his experiments they are easily carried out and he can devote the whole of his energies to making accurate adjustments and noting their results. The other man, on the contrary, must devote a great deal of his energy to tracing stray wires which have come adrift, wondering why he does not get the same readings under the same conditions as he did last night, and so on. It may seem a very obvious point, and yet it is one which is very commonly overlooked by the amateur in scientific work, and in commencing the practical part of these articles upon a very simple type of measurement I should like to lay due stress upon the vital need for a convenient arrangement for carrying them out, so that the

A Useful Measuring Unit

By G. P. KENDALL, B.Sc.,
Staff Editor.

whole attention of the experimenter will be free for making the necessary adjustments and taking the readings of the milliammeter.

General Arrangements

The instrument whose construction is to be considered is very simple in its general arrangement, since it consists merely of a convenient detector panel, carrying the valve socket, filament rheostat, grid leak and condenser, with the necessary terminals for the batteries, the milliammeter, and the external connections to the circuit across which measurements are to be made.

Use as a Wavemeter

This is all that is required for these Moullin circuit measurements, but I have also included in the unit which I use a closed oscillatory circuit consisting of a plug-in coil and variable condenser, in order that the valve may be connected across this circuit, whereupon the whole arrangement forms an extremely convenient and simple wavemeter for measuring the wavelength of a transmitter. The

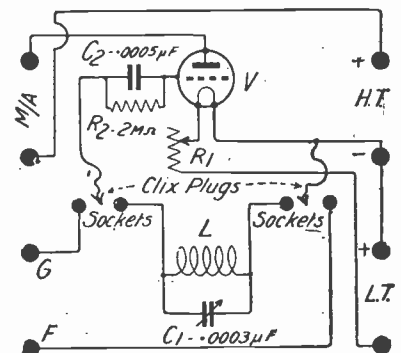

The complete circuit.

This instrument is primarily intended to serve as a transmitting wavemeter and for the form of Moullin voltmeter measurements referred to by the author in his article last week, but it has a variety of other useful applications. The constructional details of the unit are given in this article, with the necessary practical instructions to enable readers to carry out the Moullin measurements.

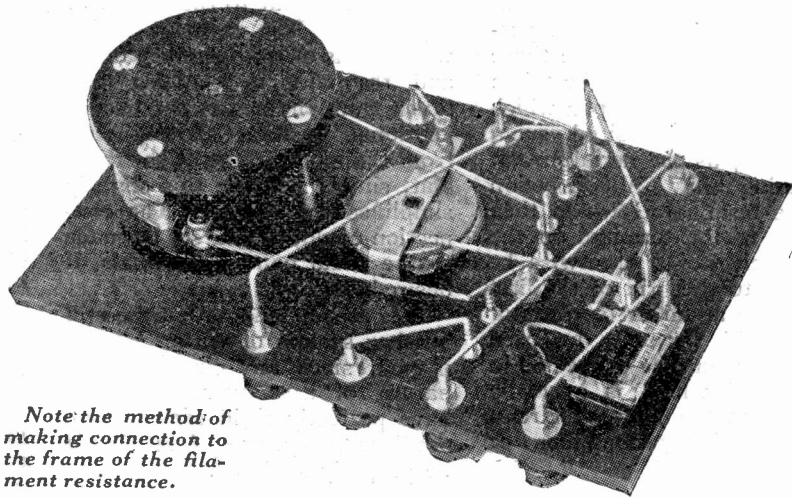

Note the method of making connection to the frame of the filament resistance.

instrument is simply placed at a convenient distance from the transmitter, a suitable coil is plugged into the socket, and the variable condenser is rotated until the millimeter needle is observed to dip suddenly, indicating that the local circuit has come into resonance with the transmitter and is picking up high-frequency currents. The variable condenser being adjusted to the point which gives the maximum deflection of the millimeter below the steady anode current reading, we know that the circuit is in exact resonance with the transmitter, and can take a reading of the wavelength, provided that the instrument has been calibrated.

Another Application

This application of the unit, of course, will only interest the

holder of a transmitting licence, but the included tuned circuit has other uses besides which render it worthy of incorporation by those who have no interest in transmitting. For example, it will form an interesting experiment to determine the strength of radiation in various directions from a frame aerial to which an oscillating valve receiver is connected, by placing the unit at a convenient distance from the frame, revolving the latter, and noting the resulting signal strength readings upon the wavemeter circuit in various settings of the frame.

The Purpose of the Clix

Leads from the grid and from

the filament circuit are brought out through two flexible connections, terminating in Clix plugs, and four Clix sockets are provided upon the panel so that the valve can be connected across either the closed circuit in the unit itself, or to the pair of terminals which can be connected by external leads to any circuit upon which measurements are to be made.

The Circuit

The circuit is illustrated in one of the diagrams which accompany this article, and should be consulted to provide an understanding of the terminal arrangement. This diagram will show how the plugs and sockets provide the

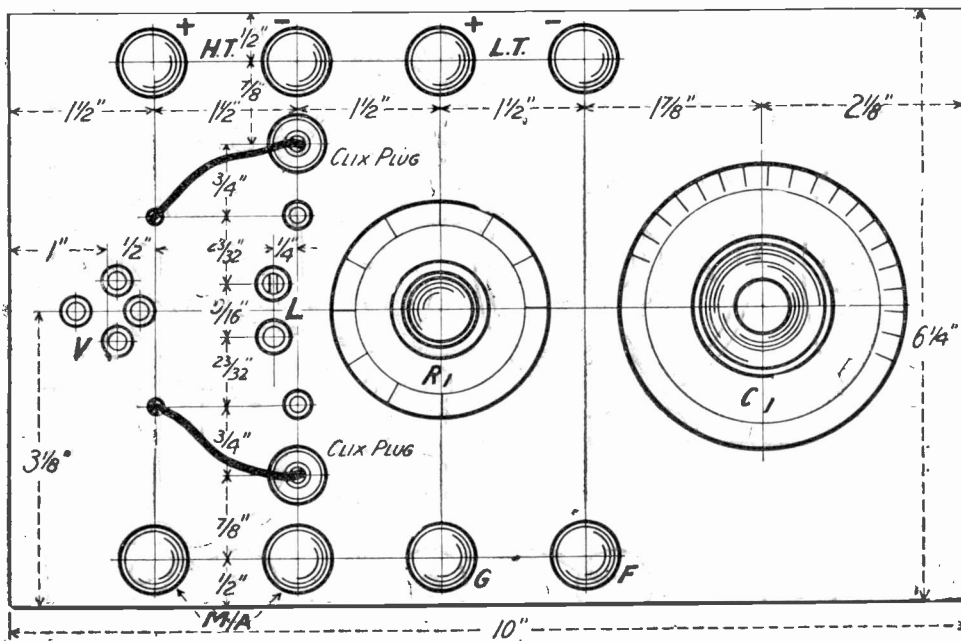

The lay-out of the original instrument is a convenient one, but it need not be followed in detail, and any available panel of approximate size will serve.

necessary alteration of connections, and it should be noted that the two terminals marked respectively "G" and "F" are those from which leads are to be taken to any external circuit upon which measurements are desired, such, for example, as the aerial circuit of a tuning unit. A connection from the terminal G would then be taken to the terminal on the tuner which would otherwise be connected to the grid of the first valve of the amplifier or detector which would normally be used with it. F would be connected to the terminal which is normally connected to the filament circuit of the receiving amplifier or detector.

Construction

Little need be said as to the actual construction of the instrument, since it is an exceedingly simple affair, and those who undertake its construction will no doubt be possessed of considerable experience. A dimensioned lay-out diagram is given of the panel, from which the drilling can be done, and the photographs and wiring diagram provide the remainder of the necessary information. One point may not perhaps be quite clear on the wiring diagram, and that is the

arrangement of the lead from the filament rheostat to the socket of the valve. The rheostat which was used is of the Igranic pattern and the wire in question was taken from the somewhat unconventional position shown, viz., from the metal frame of the rheostat, simply because this slightly simplified the wiring. The connection could, of course, be made to the usual pair of terminals, if desired.

It is recommended that the stiff bus-bar system of wiring be employed, since any circuit of the nature of a wavemeter should have perfectly rigid wiring, and, needless to say, every joint should be properly soldered.

Necessary Materials and Parts

To duplicate exactly the original instrument the following materials and components will be needed:—

- One ebonite panel, 10 x 6½ in.
- One cabinet to take above panel.
- Eight terminals (Sterling ebonite topped type).
- Two Clix plugs.
- Four Clix sockets.
- One grid condenser of .0005 μF (Dubilier).
- One gridleak of 2 megohms (Dubilier).

- Four valve leg sockets.
- One filament rheostat (Igranic).
- One variable condenser of .0003 μF, square-law type (Peto Scott).

The Variable Condenser

I have found that quite a considerable amount of difficulty may result in these measurements if the variable condenser is not provided with a particularly steady and reliable connection to the moving vanes, since the slightest irregularity here leads to a flickering effect on the milliammeter needle, which makes readings extremely difficult to take. In the condenser which I finally adopted, this connection is made by means of a metal spiral, so that the trouble is entirely removed.

To Use the Unit

When the instrument has been completed it may be tested as follows:—Connect high- and low-tension supply to the correct terminals, the voltage of each depending upon the valve which it is intended to use. Connect a pair of 'phones to the milliammeter terminals, and take leads from the G and F terminals to any convenient tuned circuit which can be adjusted to the wavelength of the local station.

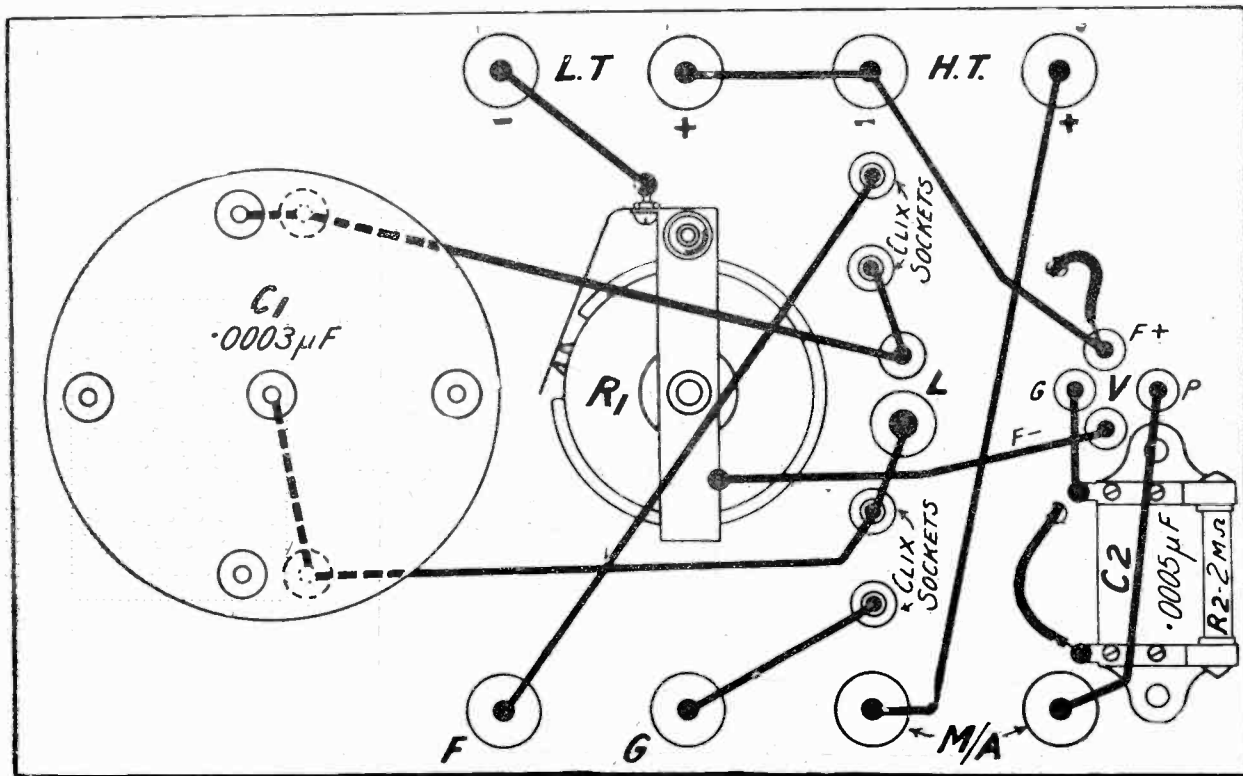

The wiring of the unit. L indicates the coil socket.

For example, aerial and earth can be connected to an ordinary receiving set of any type which may be available, the variable condenser in the receiver connected in the parallel position, and leads from the two terminals on the measuring instrument can then be taken to the aerial and earth terminals of the set.

Preliminary Test

If all the valves of the receiving set are turned out, or alternatively the catwhisker of any crystal detector lifted from the crystal, upon tuning the circuit to the wavelength of the local station, signals will be heard in the 'phones. The 'phones are now replaced by the milliammeter, and it will be found that a reading can be obtained when the receiving circuit is adjusted to resonance. One can then proceed to plug-in different coils in the coil socket of the receiving set, and note the deflection obtained below the normal anode current when the circuit is tuned to the wavelength of the transmitting station, thus obtaining a means of comparing the efficiency of various coils, the "best" coil, of course, giving the greatest change in the anode current of the valve. Again, it provides a simple test for the efficiency of the tuned circuit of a receiving set, since if the same coil is used in two different sets and it is found that one gives very much poorer signals than the other, it is fairly obvious that there is some source of loss in one of the sets.

Type of Tuner Used

This is a somewhat unsatisfactory method of carrying out the measurements, however, and it is desirable to use some tuning panel upon which coils can be tested either in series or parallel with the aerial condenser, or as a secondary circuit coil loosely coupled to the aerial circuit, and so on. In all my own experiments I have used the "Experimenter's Tuner" which I described recently in *Modern Wireless*, and this seems ideal for the purpose. Of course, quite a simple panel could be used carrying merely a coil socket, variable condenser, and the necessary terminals for the connection of aerial and earth and the measuring instrument. The three-terminal system should be adopted

for the aerial and earth connections, so that the aerial condenser can be connected in series or in parallel. Such a unit can be very quickly made, and will save one a great deal of trouble in carrying out comparative measurements upon various types of coils, and so on.

Experimental Precautions

The actual carrying out of the measurements is not quite so simple as I have perhaps implied in the foregoing description, since there are a great number of precautions which must be carefully taken to ensure anything like comparative results. In the first place, one must adopt some standard value for the anode current which represents the condition of "no signals," and a convenient figure, such as 2 milliamperes, should be decided upon.

Good Batteries Essential

This can then be maintained for the experiments by the use of a good high-tension battery (which should be fairly new) and the careful adjustment of the filament rheostat at the commencement of each set of experiments, to give the desired value of plate current. It will quite likely be found that slight variations take place in this figure in the course of any experiment covering more than half-an-hour or so, and it should therefore be made a rule to swing the tuning condenser away from the carrier wave of the station which is being used for testing, and to carefully test the "no signals" reading at quite frequent intervals. Any slight variation which is discovered must, of course, be corrected by the filament rheostat.

Valve Employed

It is further desirable that one particular valve should always be used for these measurements, and I have found the D.5.B. type very convenient. With the value of grid condenser and leak specified this valve gives a reading of 2 milliamperes, with approximately one hundred volts on the plate and a fairly suitable adjustment of filament. Of course, any valve available will serve the purpose, provided it is a fairly good detector, so that the readings shall be reasonably large.

It will quite soon be discovered

that it is comparatively difficult to repeat any given set of figures upon successive evenings, and persistent experimenting has convinced me that this is due to an actual variation in the received signal strength, even at so short a distance as eight miles from a main station. The causes of such variation are probably various, and in my own case I am inclined to put them down to the varying use of reaction by a neighbour who is at present somewhat embittering my existence. Such possible variations must be borne in mind, and one should never carry out a series of experiments extending over several evenings without the use of some sort of standard for comparison. On the contrary, each complete experiment should be carried out as rapidly as possible, so that there shall be little chance of any variation of this sort. To guard against misleading results being obtained, consequent upon a variation of signal strength, a standard of comparison should always be used, and the signal strength with this standard should be frequently measured during the progress of the main experiment.

Use of a Standard

For example, when comparing a series of commercial coils, I always insert a standard coil in the socket between each measurement, and note whether the reading of this coil is remaining constant. Any variation which is noted is regarded, of course, as cancelling the whole experiment, so that it must be started again. Actually, however, I have found it quite easy to maintain constancy over a period of something like one hour with reasonably good high- and low-tension batteries, provided always that the aforesaid neighbour does not upset the whole scheme of things in the only too familiar manner. In my own case, a very strange error was finally located in the milliammeter itself, the form which the trouble took being that of a sudden and quite inexplicable drop of the anode current at certain settings of the tuning condenser when loose coupled circuits were being used. This drop was exactly that which would have been in place if the valve had broken into oscillation,

in consequence of the use of a reaction coil. It was finally discovered that the valve was actually oscillating, owing to the fact that the windings of the milliammeter had a natural wavelength somewhere about 300 metres, so that the readings which had previously been taken were utterly valueless. The trouble was easily removed by the shunting of a large condenser (the actual size used was 2 μ F, but anything of this order will serve) across the milliammeter itself. This should always be done, whether the milliammeter is used in such measurements as this, or merely for taking the plate current of any receiver employing one or more high-frequency valves. Since shunting such a condenser across the milliammeter seems an extremely

desirable arrangement, however the latter may be used, I did not incorporate it in the measuring panel itself. It seems that it should be used externally and connected directly across the milliammeter.

It is, of course, understood that in all measurements which are intended to show the efficiency of a coil, signal strength produced by a given primary and secondary coupling, and so on, no reaction shall be used, but I should like to add a further word of warning as to the importance of endeavouring to eliminate any other possible source of error. For example, when measuring the signal strength across the secondary of a loose coupled tuner, never be satisfied that you have discovered the maximum signal strength obtainable with the given arrange-

ment until you have tried every possible variation of coupling between primary and secondary, very carefully retuning both primary and secondary circuit upon every re-adjustment of coupling. It will be seen that such measurements are therefore extremely laborious, but in no other way can really comparative results be obtained. Further, whenever you obtain results, carefully criticise all your arrangements, and ask yourself whether it is not possible that some unsuspected factor is present which may be leading to a false result. The force of this remark will become more apparent when we consider some of the measurements which I have recently carried out, notably a series upon the effect of even small quantities of moisture.

Fixing Panel Transfers

The writer, having occasion to use a large number of Radio Press panel transfers, looked round for a better method of fixing them than the orthodox way. The best method so far arrived at is the use of a small iron, or, rather, bit. Secure about 4 in. of fairly thick brass or copper strip 3-16 in. wide. One end is hammered over to form a kind of shoe ("dished," as it is usually called), and the other secured in a suitable handle.



The small tool used for fixing panel transfers.

The transfer is held down on the panel in the usual manner, and the bit inserted in a gas flame for a second or two, and then applied to the transfer, when one or two light touches will be found to be sufficient to secure the transfer to the panel. This little bit is very useful for fixing transfers against studs where usually there is only a very small space available, and in those positions where it is impossible to put a bulky piece of rag. The accompanying sketch shows the bit ready for use.

W. H. F.

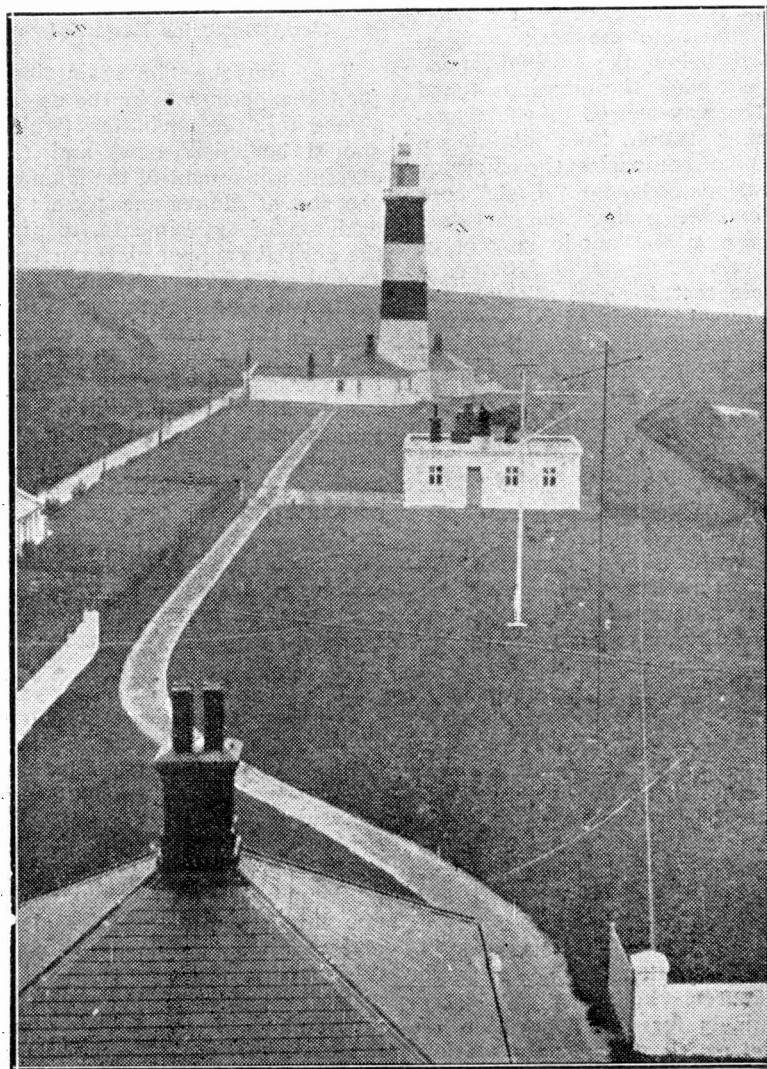

The aerial arrangements at the Nash Point station, which are used in connection with the wireless beacon.

LISSENIUM

THE CONDENSER AND THE COIL—

This new LISSEN Mark 2 MICA VARIABLE CONDENSER & LISSENIUM (pronounced LISSEN-AGON) coils.

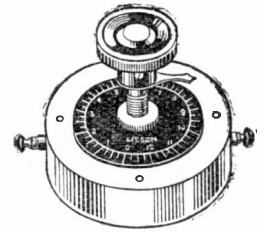

two LISSEN things which together make the finest tuning combination there is.

This LISSEN Condenser with its open scale and delightful tuning characteristics—the condenser which it is safe to prophesy will achieve a great use because it fills a great need.

On short wave work, where tuning is so critical, its open scale results in small changes of capacity for a given movement of the pointer. On long wave work you have immediately available with the same knob control the great advantage of being able to put a comparatively high capacity (the condenser is conservatively rated at .001 maximum) across the inductance without any H.F. losses through the extra shunted capacity. The inductance is thus made to cover an extremely wide range without any decrease of signal strength.

With ordinary condensers every receiver really needs two condensers—one for short wave work, and one of high capacity for long wave work. This LISSEN condenser performs the functions of both such condensers, and with greater efficiency and convenience. Its open scale and perfect capacity curve make tuning delightfully easy—it tunes along a straight line wavelength curve—it is a low loss condenser—it is dustproof—it will be noiseless for ever—it is immune from stray capacity effect—it can be used for table or panel mounting without alteration—

17/6

BUY IT, AND YOU WILL KNOW WHAT A PERFECT CONDENSER IS LIKE. Negligible minimum, maximum rated at .001. **This LISSEN Condenser gives you every capacity you will ever need—it supersedes all other Condensers—and it is totally unlike them.**

LISSEN ONE HOLE FIXING, OF COURSE.

COILS WHICH OSCILLATE EASILY.—Some coils have to be kept right close together to get them to oscillate. In that case every movement of one coil detunes the other because of the mutual interaction between coils when they are so close. Some coils cannot be kept far apart because the magnetic linkage is comparatively weak—the magnetic field may be closely concentrated in the centre of the coil, and the field may not extend. In the case of LISSENIUM (pronounced LISSEN-AGON) coils, however, the magnetic field, in addition to being very strong in the centre of the field, is also distributed on each side of the coil—the field is strong along the edges. This accounts for the strong magnetic linkage obtained with LISSENIUM coils in reaction circuits, so that the coils can be kept far apart. LISSENIUM COILS ARE COILS WITH PECULIAR EFFICIENCY.

LISSENIUM TUNING CHART.
Note the Intermediate Coils 30, 40 and 60.

No. of Coils.	TABLE I. Wavelength range when used as Primary Coils with standard P.M.G. Aerial and .001 mfd. condenser in parallel.		TABLE II. Wavelength range when used as Secondary Coils with .001 mfd. condenser in parallel.		PRICE.
	Minimum Wave-length.	Maximum Wave-length.	Minimum Wave-length.	Maximum Wave-length.	
25	185	350	100	325	4/10
30	235	440	130	425	4/10
35	285	530	160	490	4/10
40	360	675	200	635	4/10
50	480	850	250	800	5/-
60	500	950	295	900	5/4
75	600	1,300	360	1,100	5/4
100	820	1,700	500	1,550	6/6
150	965	2,300	700	2,150	7/7
200	1,885	3,200	925	3,000	8/5
250	2,300	3,800	1,100	3,600	8/8
300	2,500	4,600	1,400	4,300	9/2

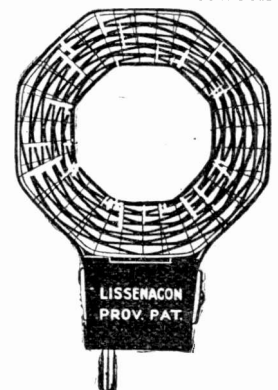

IF YOU EVER WANT COILS WHICH INTENSIFY TUNING — USE LISSENIUM COILS.

LISSEN LIMITED 30-32, Woodger Road, Goldhawk Road, LONDON, W.12
DON'T MIX YOUR PARTS—There is a LISSEN Part for every vital place

It will pay you always to watch WIRELESS WEEKLY Advertisements.

LISSENIUM

Put a fine edge on your tuning

The advantages of LISSENSTAT control are so great that those who want fine detection and know how to get it will have nothing else but LISSENSTAT control for the filament current of the valve. Not only does it keep valves quiet, pass a steady, unvarying current, remain noiseless from the first turn to the last, but by its critical control of electronic flow it gives the valve a capacity to detect as no other rheostat can. LISSENSTAT control adds range to a receiver because you can feel for the point of critical detection and unerringly find it.

Sold in three models :—

LISSENSTAT MINOR (patents pending) is replacing many thousands of inefficient rheostats—provides LISSENSTAT control at a popular price **3/6**

LISSENSTAT MAJOR (patents pending) gives the most acute tuning possible .. **7/6**

LISSENSTAT UNIVERSAL (patents pending) with its protective device for dull emitters **10/6**

Minute Grid Currents

The leak which gives you the necessary control over the minute currents flowing in the grid of your valve is the LISSEN Variable Grid Leak (pats. pending). See that you get the one with the nickel fittings. This is the latest type, and it represents a very high degree of efficiency in the control of grid potential. Its fitting in a receiver is very necessary if the operator is keen on getting that extra sensitivity which results in clear, strong signals when otherwise they would be weak and obscure. Every resistance value required of a leak is covered. **LISSEN ONE-HOLE FIXING, OF COURSE** **2/6**

LISSEN Variable Anode Resistance, 20,000 to 250,000 ohms, same outward appearance as the LISSEN Variable Grid Leak **2/6**

Smooth out your Loud-Speaker distortion by putting the LISSEN Variable Grid Leak across the secondary of the last Transformer, or across the Loud Speaker itself—first position is the better.

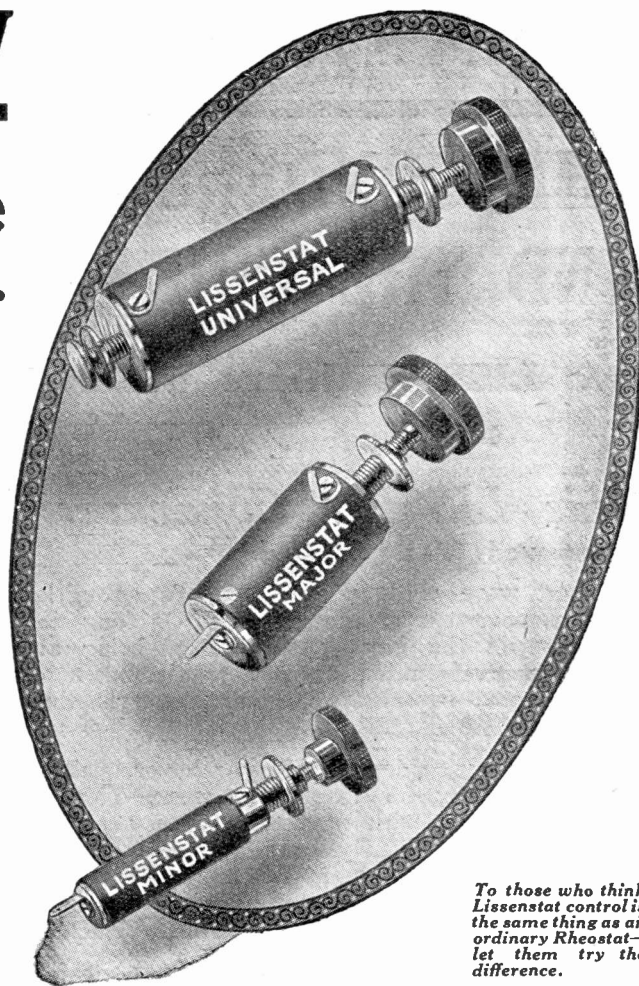

To those who think Lisssenstat control is the same thing as an ordinary Rheostat—let them try the difference.

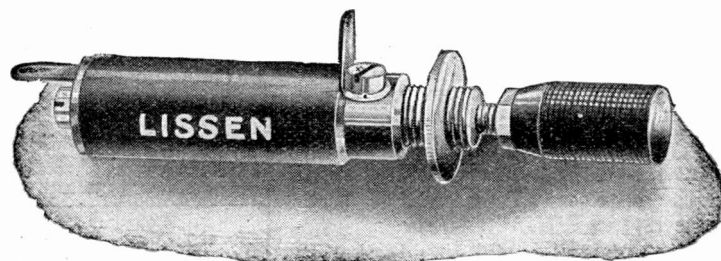

LISSEN LIMITED 30-32, Woodger Road, Goldhawk Road, London, W.12
 Telephones—Riverside 3380, 3381, 3382, 1072. Telegrams—"Lisssenium, London."
BUILD—WITH YOUR OWN HANDS—WITH ALL LISSEN PARTS.

It will pay you always to watch WIRELESS WEEKLY Advertisements.

THE resistance - capacity method is becoming very popular nowadays as a means of coupling low-frequency valves. The main reason for this is that with this type of coupling there is practically no over-emphasis of certain tones, so that distortionless amplification over a very wide range can be obtained.

The Resistocap Unit

By R. W. HALLOWS, M.A.

in Fig. 1, which gives extremely good results. Amplification is obtained by means of the transformer between the first and second valves shown and the

be constant and it may be noisy. The value of the resistance R_1 in Fig. 2 may be 50,000-100,000 ohms.

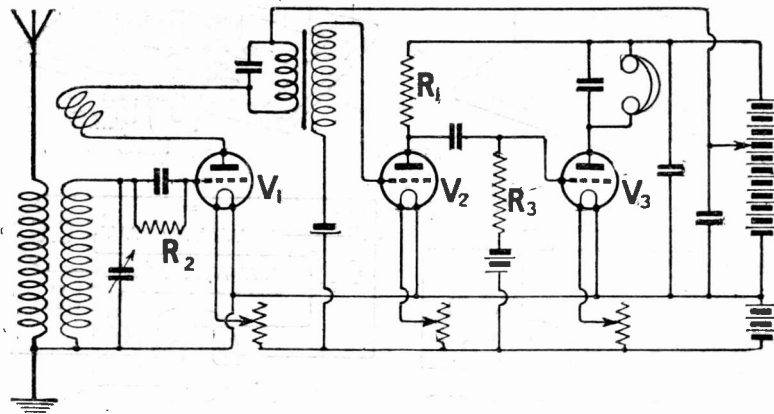

Fig. 1.—One transformer coupled, and one resistance coupled note magnifier form a good combination.

It struck me some time ago that it would be a good idea to make up some small resistance-capacity units which could be used in any set to replace existing transformers, if desired, and when I came to construct them I

resistance-capacity coupling between the second and third valves gives a further amount of amplification without noisiness or distortion. Notice that in the circuit it is essential to provide two high-tension positive terminals, since a much higher voltage is required on the note magnifiers than on the rectifier. Between the plate of V_2 and H.T. + is the resistance R_1 , across which there is a drop in voltage. To compensate for this we require to use a higher value of H.T. for this valve.

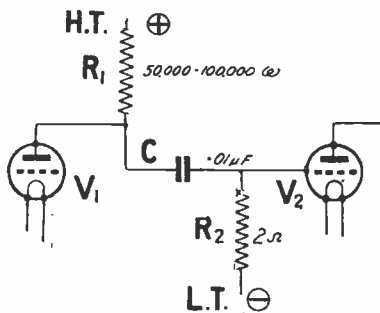

Fig. 2.—Details of the resistance coupling connections.

found that they were extremely useful in every way. One can use them, if desired, to replace permanently an existing transformer, or the set may be so arranged that by means of Clix terminals either the transformer or the Resistocap, as I have called this unit, may be brought into action. Where only one stage of note magnification is used it is probably preferable to employ transformer coupling. With two stages I have a strong liking for the combination shown

Resistance Coupling

Fig. 2 shows diagrammatically the details of the resistance coupling. The actual coupling between the plate of V_1 in the drawing and V_2 is provided by a coupling condenser (C). Condensers up to .25 μ F have been used in this position, but excellent results are to be obtained with a capacity of .01 μ F. Now a condenser of this size can be obtained quite cheaply in the clip-in type with a mica dielectric. Since the grid of V_2 is insulated by the coupling condenser C, a leak, R_2 , must be provided. A suitable value for this is 2 megohms, and it is essential that the leak used should be of the best quality, for otherwise its resistance may not

Wiring up the Unit

A wiring diagram of the Resistocap Unit is shown in Fig. 3. It will be seen that its four terminals correspond to those of a low-frequency transformer, so that connections can be made without difficulty. If the circuits are traced out it will be seen that the plate is connected *via* the terminal marked A, both to the coupling condenser (C) and to the anode resistance R_1 , the other end of which is taken to the H.T. + terminal. The other side of the coupling condenser is taken to one end of the gridleak R_2 , the other end being connected to the L.T. - terminal.

To make a Resistocap Unit a

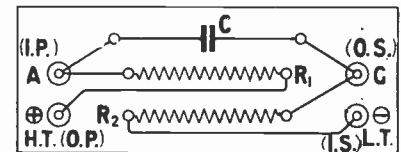

Fig. 3.—The wiring of the Resistocap Unit.

piece of $\frac{1}{4}$ -in. ebonite 5 in. by $2\frac{1}{4}$ in. is required. This is marked out and drilled, as shown in Fig. 4. At the top is the clip-in condenser, whose clips are fixed by 4 B.A. screws placed in holes 3 in. from centre to centre. Anode resistances vary somewhat in length, so that the distance between the centres of the second

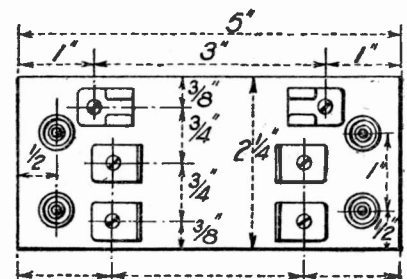

Fig. 4.—Drilling dimensions.

pair of holes may have to be altered. The space given there,

namely, $2\frac{1}{2}$ in., is about the average. The same remark applies to the gridleak. The four terminals are placed in two pairs, $\frac{1}{2}$ in. from each of the short edges and 1 in. apart. All the holes shown are $\frac{1}{4}$ B.A. clearance. One of these units can be made up in half an hour in the workshop, and the time spent will be amply repaid, since the couplings turned out are so compact and can be wired up in the set in a couple of minutes.

Interchangeable Units

If it is desired to make resistance capacity and transformer very rapidly interchangeable, the idea shown in Fig. 5 may be used. The transformer is mounted upon a small block of ebonite provided with four valves legs spaced in the ordinary way to which leads are taken from its terminals. It simplifies matters if the plate connection of the transformer is made to the plate leg and the grid connection to the grid leg.

One of the filament legs becomes H.T. + and the other L.T. -. The Resistocap Unit may have a similar mounting and is connected up on the same lines, as

shown in Fig. 6. To interchange one circuit for the other all that one has to do is to pull out the transformer and to plug in the Resistocap.

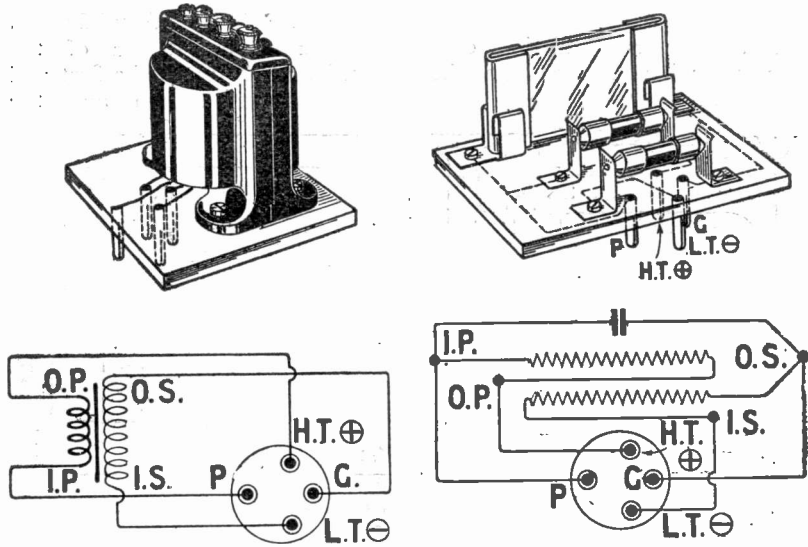

Figs. 5 and 6.—Illustrating how the interchangeable units are mounted and connected.

20D

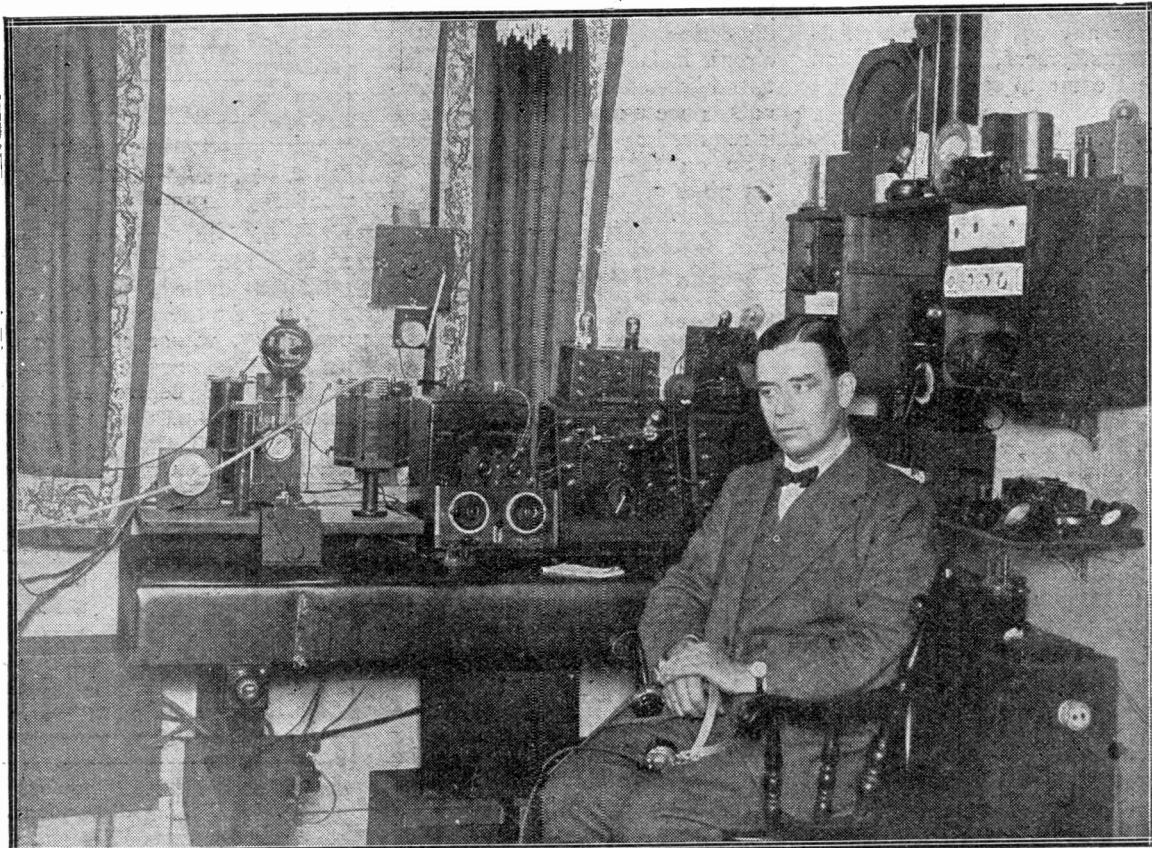

Our photograph shows Mr. E. J. Simmonds, of Gerrard's Cross, whose success in long distance transmission and reception is well known.

The Very Latest IN Crystal Detectors



(Registered Trade Mark)

PATENT "UNIT" CRYSTAL DETECTOR

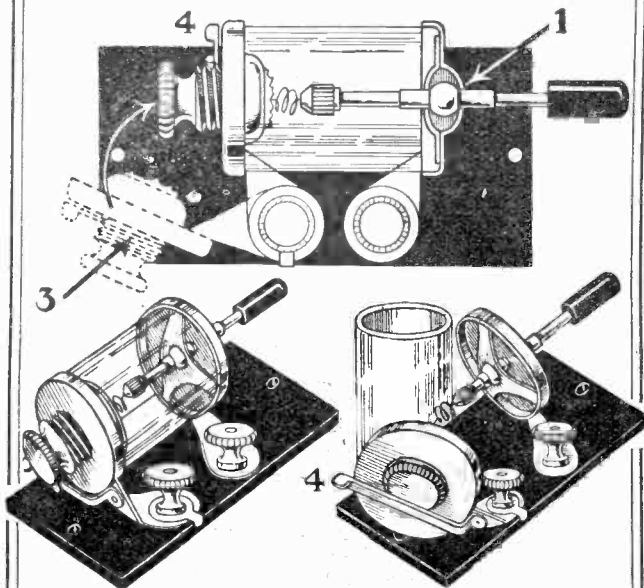

Important and Unique Features

- (1) The universal ball joint is not dependent upon the usual crude support between the tube and pedestal, but is SELF-CONTAINED in a special spring cage. The detector arm is SELF-CENTERING, having a perfect movement, enabling CONSTANT CONTACT to be maintained. THE CAT'S WHISKER WILL REMAIN IN PERMANENT POSITION AT POINT OF ADJUSTMENT.
- (2) The tube housing and pedestal are built in one unit.
- (3) The crystal is BREECH FED, and can be adjusted or replaced from the OUTSIDE of tube by simply removing the screwed plug.
- (4) INSTANT ACCESSIBILITY. By merely lifting the small lever the pedestal can be swung clear of the tube—giving instant accessibility to ANY PART, without dismounting or disarranging ANY OTHER part.

PRICES.

Cat. No. B.C.32. For Panel Mounting **2/-** each

Cat. No. B.C.34. Mounted on Base **2/6** each

NOTE.—Prices do not include Crystal.
"GECOSITE" CRYSTALS for use with above, price 1/3 per piece.
**SOLD BY ALL GECOPHONE SERVICE DEPOTS,
ELECTRICAL & WIRELESS DEALERS, STORES, ETC.**

Wholesale only: The General Electric Co., Ltd.
Head Office: Magnet House, Kingsway, London, W.C.2.

DUCO

VERNIER COIL HOLDER

(Prov. Patent.)

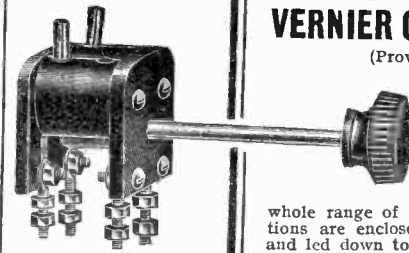

No. RC50/4 Two-way
each 5/-

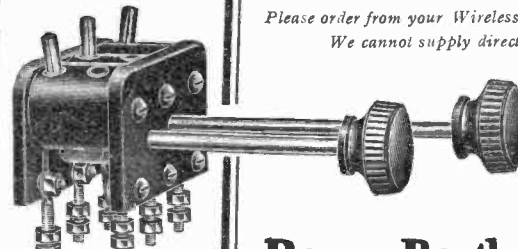

No. RC50/5 Three-way
each 7/6

Provides Vernier control of moving member in any position. No backlash. Vernier control is in operation always—throughout the whole range of movement. Connections are enclosed within the holder and led down to the securing screws, thus obviating loose and broken wires. Guarantees tuning of extreme accuracy. Solid ebonite. Heavily plated fittings.

Please order from your Wireless Dealer.
We cannot supply direct.

Brown Brothers
Associated Companies: Thomson & Brown Brothers, Ltd., Brown Brothers (Ireland), Ltd.

Wholesale only: Head Offices and Warehouses:
GREAT EASTERN ST., LONDON, E.C.2
118, George St., Edinburgh, & Branches.

ALL POST FREE AT		CALLERS' PRICES	
Ebonite Panels.	COMPLETES	TRADE	Var. Condensers
Matt. 1/2 3/10	P	E	.001 panel type 6/6
9" x 6" 2/2 1/10	R	N	.00075 (Knob & 5/6
12" x 9" 4/6 3/8	I	Q	.0005 (dial in- 5/6
12" x 12" 5/0 5/-	C	U	.0003 (clutd. 4/6
15" x 9" 5/6 4/8	E	R	.0002 3/8
15" x 12" 7/8 5/8	L	I	Stock "Square-Law,"
4" x 4" 8d. 6d.	L	R	"J.B.," "Ormond" &
7" x 5" 1/6 1/2	S	E	"Utility" usual prices
6" x 6" 1/6 10d.	T	S	Vernier, no dial 2/6
Any size cut.	FREE		5 vane 3/8, 7 3/6
Sq. in. 1/2 id., 1" id.			Polar types 10/6
Terminals.	Condensers	Variable Leaks	New Lines.
Mil.-Pol. Brass 2d.	Dublier	Filteron 0-7 meg. 2/6	Eureka Transformers
4 B.A. Standard 1d.	Mulhard (Usual)	Watmel 0-5 meg. 2/6	No. 2 .. 22/6
Lacquered 2d.	Edison-Bell (prices)	Lisson type .. 2/6	Concert Grand 30/-
Spade type, doz. 3d.	Manbridge 1 m.f. 1/6	Resistances 2/6	R.I. Chokes .. 10/-
Telephone type 1/4d.	2mf. 1/6, 1/36 mf. 9d		Shaw's Hertzite 1/-
Multiphone 4w. 9d.			
6-way 1/-	Headphones.	Ebonite Dials.	Jacks 4-Contact.
Reffy spring 3d.	4,000 ohms. Brown's	Engraved 3" .. 7d.	Bank of 2 .. 1/6
2 B.A. Small 1d.	"F." B.T.H., Siemens,	Knobbed type 1/1	Single Jacks 1/3
Contact Studs 1d.	Brandes. Sterling.	2 1/2" Fl. Type 8d.	Standard Plugs 1/8
Spring Washers 1d.	Ericsson, all 25/-	Transformers L.F.	Potentiometer 300
Aerial Wire 7/22's	General radio 20/-	Radio Inst. (new) 25/-	ohms ex-Govt. 5/-
Enamid. Bright	Sellowans 18/6	Silvertron .. 21/-	Hydrometers .. 3/6
100' 3/8	Air weight 10/6	Igranite 21/- & 20/-	Microphones .. 2/-
Electron 1/3	.. Adjustable 12/6	Burndep (new) 24/-	Tapping Keys 2/-
" Mars 9/6	H. T. Batteries.	Reliability 10/- & 12/6	H'dphone Cords 1/6
Lead-in 4d. yd.	With Wander Plugs.	Ferranti .. 17/6	Alum. H'dbands. 2/6
	60v. 2/- 36v. 4/10	Xtraordinary .. 8/-	All "Igranite" "Lis-
Insulators.	30v. 4/- 18v. 2/-	Tangent 12/6 & 14/6	son," "Burnapt,"
Shell, 2 1/2" x 2 1/2" 4d.	4v. F.L. Btry 5d.	Royal .. 20/-	"Edison-Bell," "Atlas"
Reel 1d., Rgs 1d.	65v. Ever-Rly 13/6	R.A.F. Modulation.	& "Sterling" Goods.
Cryator type 9d.	36v. 8/- 18v. 3/8	Reliability 10/- & 12/6	Coil Holders.
Lead-in .. 1/4d.	Siemens same price.	"Unduly" all 8/-	Ashley fixed .. 2/6
4" x 6" do. 6d.	British Wires.	H.F. Tangent .. 5/6	.. moving .. 3/6
6" x 6" do. 9d.	swg. dec. sec. dec.	McMichael's .. 10/-	Igranite 3 Set .. 8/6
Valve Holders.	18 1/11 2/11 3/5	OoJah 900 .. 5/6	Ebonite 3 Coil 3/8
Type A 7d., Polar 1/3	20 2/2 3/4 4/2	.. 300 m. 4/6	.. 2 Coil 2/6
Screwed nuts 3d.	22 2/8 3/9 4/7	Formers only .. 1/-	Single moving 1/6
Ebonite .. 10d.	24 2/11 3/10 5/-	Fl. Resistances.	Fixed typ. 8d.
Do. Open-Type 6d.	26 3/4 4/2 5/8	Good quality .. 1/6	Recessed do. .. 8d.
Coil Plugs.	28 3/9 4/9 6/6	Igranite .. 4/6	Switches Ebonite
Ebonite 10d.	30 4/10 5/4 7/6	Vernier type .. 7/-	"Tumbler 1 1/2 1/6
Superior 1/3	32 5/6 6/- 8/9	Ormond 2/- Ajax 4/-	D.C.O. .. 1/6
Narrow 7d.	36 8/- 8/6 12/-	Burndep .. 5/-	S.C.O. .. 9d.
Basket 1/-	40 17/- 14/8 20/-	T.C.B. 4/- & 5/-	Dewar D.C.O. 3/8
Moulded type 6d.		Microstat .. 2/6	D.E.S.T. 2/8
Coil Formers 24d.		Peerless Jnr. .. 2/6	Utility 2-way .. 4/-
Basket type 18d.		Mic-Met-Detector 5/-	3w 6/- 4w 6/- 6w 8/-
Coil Mounts 4d.		Amplion Jnr. .. 27/6	Lever Type Stocked
Do. Ebonite 1/3			Mixture Turn 8d.
Do. Porcelain 1/-			Lisson 2-way .. 2/6
Basket Coil Sets,			Series pari. 3/8
6-1/8, 1-1/2			Double-arm do. 3/-
Iron Core Chokes,			
1,000 ohms .. 8d.			

Brandes

The name to know in Radio

All Brandes products carry our official money-back guarantee, enabling you to return them within 10 days if dissatisfied. This really constitutes a free trial. Brit. Manuf. (B.B.C. Stamp).



-for Young Bill

The fever of the experimenter has fired young Bill's ambition. In the picturesque vernacular of our American friends he's "cottoned on to the hull bunch"—vacuum tubes, hook-ups, new wave bands, right down to the last binding post. He tunes in the distant stations now with his *Matched Tone* Headphones, and is content. They bring in the faintest signals, their delicate supersensitivity making them unexcelled for long range telephony.

And the *Table-Talker* is just fine. To his credit, Bill refuses to acknowledge the family's praise. "It's not me tinkering about," he says, "the *Table-Talker* always came through as if you were actually in the studio, and with no scratchy notes." Ask your Dealer for Brandes.

Tune the Table-Talker

42/-

- with the Matched Tone Headphones

25/-

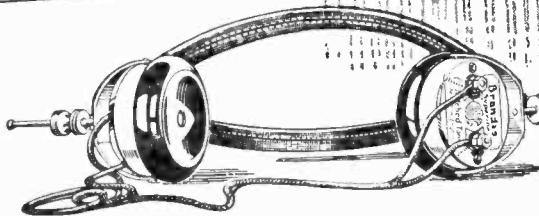

It will pay you always to watch WIRELESS WEEKLY Advertisements.

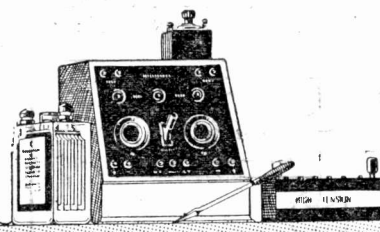
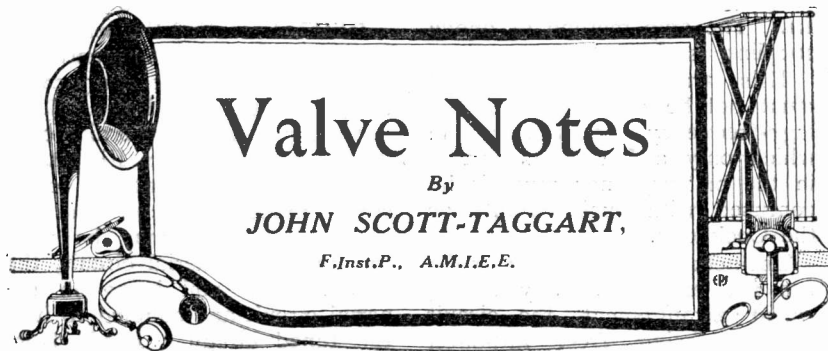

Selectivity

AS a result of recent experiment with a view to obtaining greater selectivity, I have developed a new method of coupling valves for high-frequency amplification.

Excluding the T.A.T. system the usual arrangements consist of tuned anode circuits, choke coils, resistances and trans-

ance coil L₂, consisting of a few turns, to which is coupled the inductance L₃, usually containing many more turns. The inductance L₃ is shunted by the variable condenser C₂, which tunes the circuit L₃ C₂ to the incoming wavelength.

Coil Values

For ordinary broadcast wavelength purposes (300 to 500

Operation

The anode trap coupling method shown in Fig. 1 is operated in just the same way as a tuned anode circuit in that the circuit L₃ C₂ is the controlling factor, and all adjustments may be made by altering L₃ or C₂, or both.

The effect of this arrangement produces the same result as if the coil L₂ were tuned, the circuit L₃ C₂, of course, is not connected to anything else.

Without the circuit L₃ C₂, the coil L₂ acts simply as a plain inductance, and since it contains only a few turns, the high-frequency potentials communicated to the grid of the second valve are negligible, the coil acts little differently from a plain wire. If the coil, of course, were much larger, it might act as a choke coil, and so serve as a means of coupling the valves together.

If the circuit L₃ C₂ is not tuned exactly to the same wavelength as the incoming signal, the impedance of L₂ remains normal, and no signals will be heard. If,

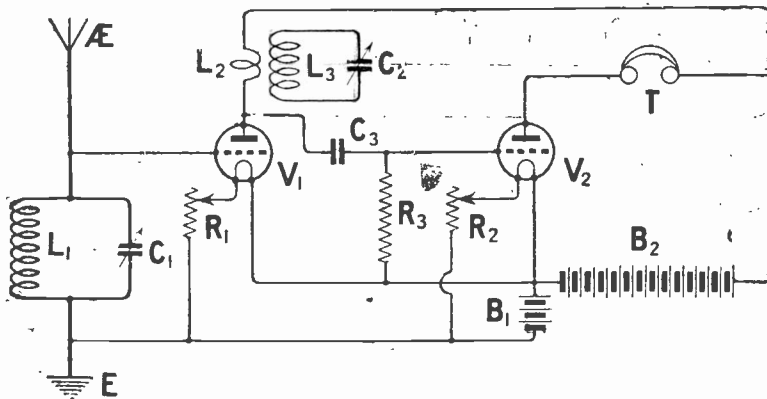

Fig. 1.—Illustrating the arrangement of the anode trap.

formers having one or other, or both, windings tuned.

Anode Trap Coupling

The new method I have called "anode trap coupling," because the circuit involved is somewhat similar to that in wavetraps.

While giving equally good signal strength, the arrangement about to be described is extremely selective, and is yet perfectly simple to work, only one control (a variable condenser) being necessary.

The Arrangement

Fig. 1 shows the arrangement of the anode trap in use. It will be seen that instead of using a tuned anode circuit, the anode of the first valve contains an induct-

metres), the coil L₂ may be a plug-in coil of from 8 to 25 turns, while the coil L₃ will usually be a No. 50 plug-in coil, while C₂ may be a .0003 μF or .0005 μF variable condenser. If plug-in coils are used, L₂ and L₃ may be placed absolutely side by side. An alternative arrangement is to use a high-frequency transformer and to tune the secondary of it. This will not usually give as selective results, because the primary has usually about the same number of turns as the secondary, whereas the fewer the turns the greater the selectivity in the anode trap arrangement.

It is, of course, often also possible to use low-loss coils wound with thick wire and having about 10 turns wound round the middle of the larger coil.

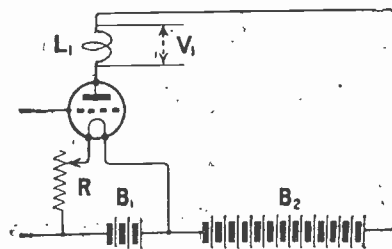

Fig. 2.—When H.F. potentials are applied to the grid the E.M.F.'s across L₁ will be small.

however, the circuit L₃ C₂ is exactly in tune, the signals will be as loud as if a tuned anode circuit were employed, but the selectivity will be extraordinarily marked, even when no reaction is used in the circuit at all.

Fig. 2 shows the simple coil L_1 in the anode circuit of the valve. If high-frequency potentials are

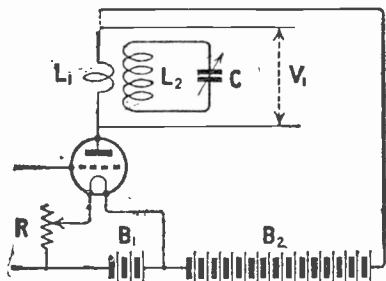

Fig. 3.—The impedance of L_1 will rise when $L_2 C$ is tuned to the aerial circuit.

applied to the grid circuit, the E.M.F.'s V_1 established across L_1 , which consists of only a few turns, will be negligible. If, on the other hand, we can couple sufficiently tightly to L_1 a tuned circuit $L_2 C$, as shown in Fig. 3, the impedance of L_1 will rise to a very high value when $L_2 C$ is tuned to the same frequency as the currents applied to the grid of the valve. In this case the E.M.F.'s V_1 established across L_1 will be large.

A Two-Valve Reaction Circuit

A simple two-valve circuit using reaction is illustrated in Fig. 4, the reaction coil L_4 being

coupled to the aerial inductance L_1 . The trap method of anode coupling is shown.

This trap coupling method must not be confused with the high-frequency transformer in which only a few turns appear in the primary, nor must it be confused with such circuits as the Cockaday.

The actual oscillations in $L_3 C_2$ are not applied to any subsequent arrangement, the circuit $L_3 C_2$ being free, although having such an important inductive effect on the anode circuit of the valve.

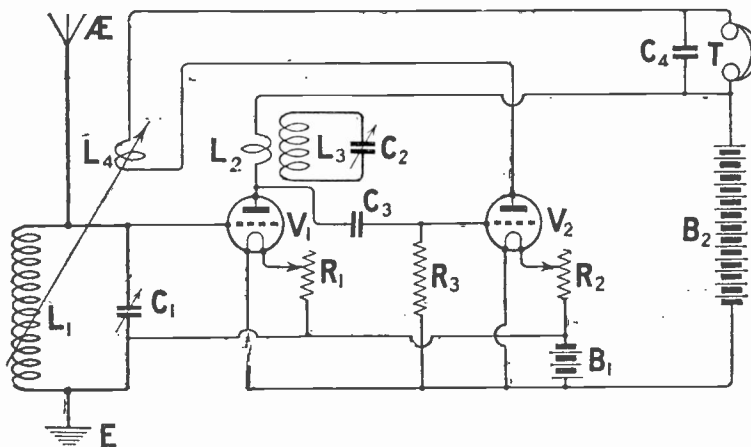
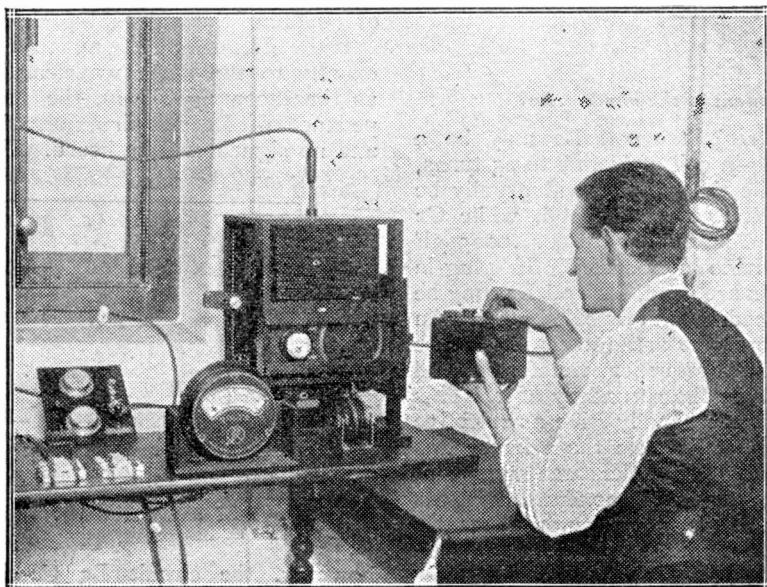

Fig. 4.—An even more selective circuit is obtained by the use of reaction.

NASH POINT WIRELESS BEACON



The six months' tests of the first British experimental wireless beacon at Nash Point, Bristol Channel have proved very successful. The beacon sends a signal intermittently on a fixed wavelength so that ships that have lost their bearings can locate it. Our photograph shows the quenched spark set.

Some further results with the Low Loss Tuner for Short Waves

SIR,—I thought you would like to know that I have made up the "Low Loss Tuner for Short Waves," Mr. Percy W. Harris (*Wireless Weekly*, November 19, 1924), and I have received KDKA three nights in succession without difficulty, starting at 11.30. I have been using an old condenser, as there seems to be some delay in getting the one suggested, but hope to try it out soon.

My standard set is the "Transatlantic V," and is very good for WGY; I have been able to get him every time I have tried so far, once on the loud-speaker for an hour and a half. Valves used:—Two Cosors, Mullard detector, DE 5b and LS5.—Yours faithfully,

H. L. WILLEY.

Sheffield.



INDISPENSABLES TO MAXIMUM RADIO EFFICIENCY



GOOD COMPONENTS DESERVE A GOOD PANEL

Uniform Fine Grain, Dead Matt Finish. **GUARANTEED** Non-Metallic Surface, free of leakage.

Tested and Recommended by **MODERN WIRELESS.**

PARAGON Radio Quality Post Office Specification "The Best Made." **EBONITE PANELS**

Special panels for Receivers described in this or any previous issue of **RADIO PRESS PUBLICATIONS**—CUT, EDGES SQUARED and GROUND, 3/4d. per square inch. Prices for drilling and engraving upon request.

Home Constructors who wish to be certain of perfect reception should apply for our 16 pages Catalogue of "Essential Raw Materials and Accessories," post free on request.

STANDARD SIZES.			
8 x 6 x 1/4	2/6	24 x 10 x 1/4	14/6
8 x 6 x 3/8	3/3	24 x 12 x 1/4	17/6
10 1/2 x 8 1/2 x 1/4	5/3	8 x 5 1/2 x 1/4	2/9
12 x 10 x 1/4	7/3	10 1/2 x 7 x 1/4	4/7
12 x 12 x 1/4	8/6	12 x 6 x 1/4	4/6
14 x 12 x 1/4	10/-	22 x 11 x 1/4	15/3
16 x 12 x 1/4	11/6	15 x 9 x 1/4	9/-
19 x 12 x 1/4	13/-	12 x 11 x 1/4	8/3
18 x 6 x 1/4	6/9	12 x 8 x 1/4	6/-
10 x 8 x 1/4	6/9	7 x 5 x 1/4	2/3
10 x 9 x 1/4	5/8	10 x 5 1/2 x 1/4	5
10 x 5 x 1/4	3	10 x 5 x 1/4	3
12 1/2 x 9 1/2 x 1/4	7/6		

PARAGON POLISHED MAHOGANY EBONITE

Is NOT a composition, but **GUARANTEED POST OFFICE QUALITY EBONITE**, and is of similar specification to the now universally used **PARAGON EBONITE**.

PANELS CUT TO SIZE, Squared, edges ground, 1d. per square inch. Valves and Coil Holders, Condenser Dials and Knobs, in Polished Mahogany Finish to match.

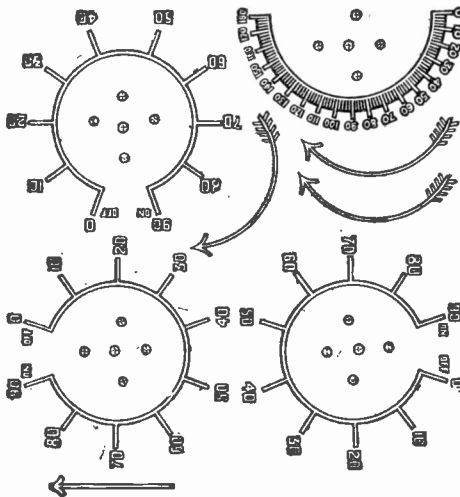

AERIAL EARTH TUNER REACTION CONDENSER TELEPHONES SERIES CRYSTAL AND/OR INPUT H.T. H.T. ON ON L.T. L.T. OFF ON H.F. H.F. L.E. L.E. VALVES A.T. I.A.T. I OUTPUT H.F. C.A.T.C REC. LOUD SPEAKER ON (A) (E) (D) DET. AMPLIFIER PARALLEL MAX. A.T.L.C. REGEN. OFF OFF OFF OFF + + + + - - - - POTENTIOMETER DUAL LEADING COIL, FINE 1 2 3 4 5 6 7 8 9 10 11 12 REACTION GRID BIAS A B C D E F G GRID LEAK COARSE REVERSE 1ev RESISTANCE JACK 2ev RESISTANCE PLUG CAPACITY VERNIER VARIOMETER H. F. C.

THE "NU-GRAVING" PANEL MARKING PROCESS.

Series 10. Complete as shown, 6d.

This name on every envelope is your only guarantee against spurious imitations. Nu-graving is guaranteed for an indefinite period against chipping or cracking.

CURTIS CONSTANT-TUNED H.F. AMPLIFIER

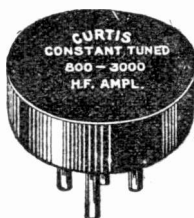

No Tuning Condenser Required.

The Curtis "Constant-Tuned" High-Frequency Amplifier is the only automatic high-frequency amplifier which guarantees high efficiency for two stages of radio amplification on any wave-lengths between 300 and 3,000 metres, and requires no additional controls. For the greater convenience of the constructor and to conform to existing panel designs, the CURTIS CONSTANT-TUNED is designed with the orthodox 4-pin plug for panel mounting, and must be connected in accordance with the circuit diagram supplied.

"Using the Curtis Amplifier and the Duodyne Circuit I receive all British Stations with an indoor aerial on a Set made by myself." J. S.—Tufnell Park.

Model A, 300 to 800 metres, 15/-, postage 6d.
Model B, 800 to 3,000 metres, 17/6, postage 6d.

PARAGON-CURTIS ONE-PIECE MICA CONDENSER.



Guaranteed uniform accuracy under all conditions and at all temperatures.

Extract from a recent "Wireless Weekly" Test Report—"There was observed but a negligible greater high-frequency loss in this type than in a standard air-dielectric condenser . . . An exceedingly strenuous test was applied to one of the samples, which was actually placed in water nearly at the boiling point for the better part of an hour. After this heroic treatment, the condenser showed a capacity which did not differ materially from that shown before, and it was still possible to get a valve to oscillate readily with this as the main tuning capacity across the grid-tuning inductance."

.0008 to .006, 2/6; Complete with Grid leak Clips, 2/9; Grid leak, 1/6.

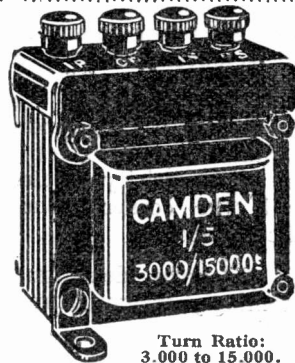

WE HAVE NO HESITATION in confidently recommending the **CAMDEN INTERVALVE TRANSFORMER**

for maximum power amazingly free from distortion. This component carries our full guarantee.

Price - - 12/6

Turn Ratio: 3,000 to 15,000.

PETER CURTIS LTD.

75 · CAMDEN ROAD · N.W.1.

Telegrams: "PARACURTEX" — 'Phone: NORTH 3112.

IN CONJUNCTION WITH

The **PARAGON RUBBER MFG. CO. LTD.** HULL

BIRMINGHAM: 76, Newhall Street. Central 7238.
MANCHESTER: 312, Deansgate. Central 5095.

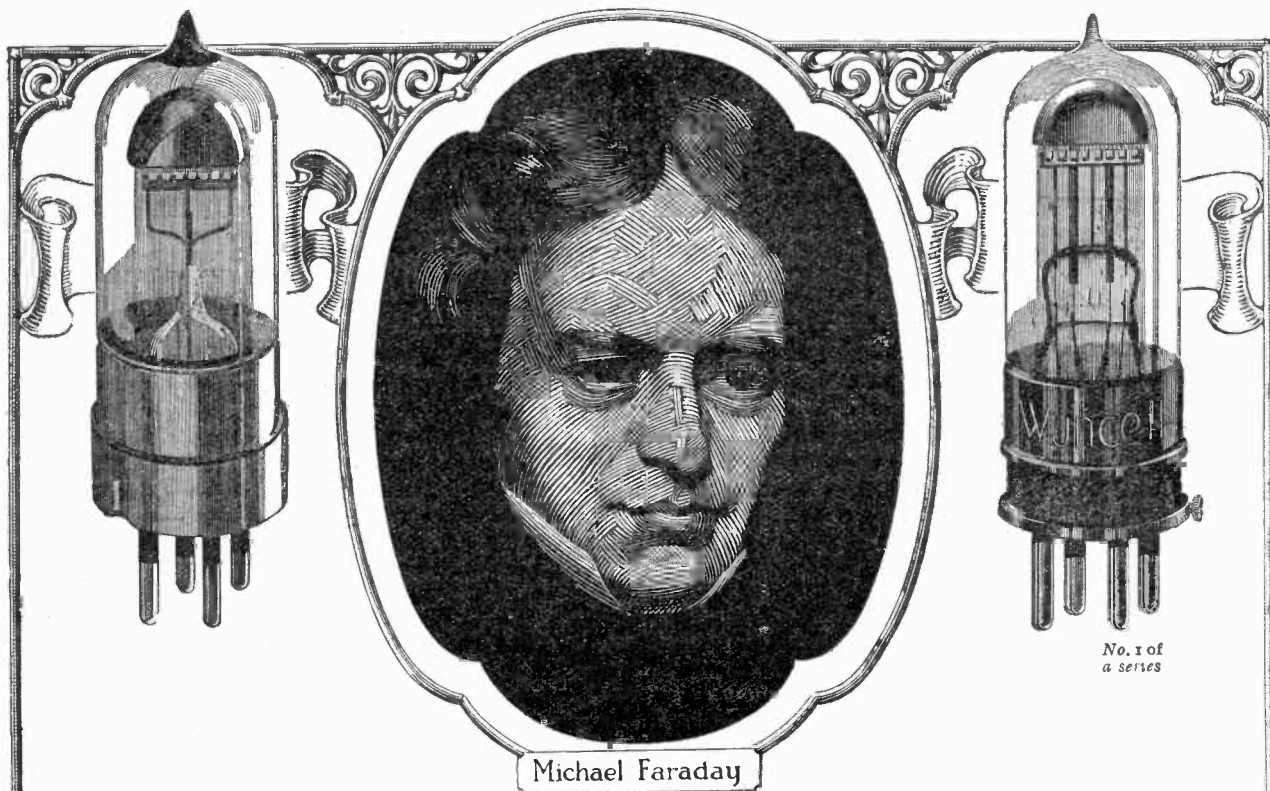

No. 1 of a series

The birth of a great idea.

TO Michael Faraday we owe the discovery of induced currents. From his first simple experiment of winding two lengths of silk-covered wires around a wooden cylinder, and placing in circuit with the one a simple battery and between the ends of the other a galvanometer, has sprung most of the great electrical achievements of to-day.

Without Faraday's masterpiece there could have been no electric motors, generators, or transformers—in fact, the whole structure of electricity is closely interlocked with the corner stone of electro-magnetic induction.

Truly the birth of a great idea from one simple and seemingly insignificant discovery.

And in its way the invention of the Cossor Valve provides a striking analogy.

Here you see the inventor carefully considering the action of the thermionic valve. How its whole success is bound up in the efficient use of the electron stream given off by the filament. He, too, gets a great idea. If electrical measurements so conclusively prove that losses in electron emission mean losses in signal strength and sensitiveness, then why not re-design the Valve to keep these losses down to a minimum.

And so you see the inventor's dream crystallised into practical reality with the familiar arched filament almost totally surrounded by the hood-shaped anode of the Cossor Valve.

Cossor Valves

Your Lead-In

IT is surprising to find when visiting the houses of friends and acquaintances how very inefficient a large number of aerials are. Sometimes, of course, inefficiency is the result of circumstances which cannot be helped. An aerial, for instance, may have to be low on account of crossing telephone or telegraph wires, or it may have to be short because the size of the garden will

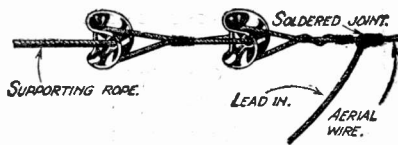

Fig. 1.—A common form of down-lead connection.

not allow it to have a big span. In the majority of cases, where the aerial is not up to the mark, the defect is often to be found in the lead-in. One of the commonest aerial arrangements is that seen in Fig. 1, where the down-lead is attached to the aerial wire by means of a soldered joint.

The Joint

Now such a joint, unless it is exceedingly well made, is apt to be a source of trouble in time to come. Unless every strand of both down-lead and aerial are firmly soldered there may be considerable resistance at the joint. Further, as time goes on, the effects of the weather may cause the joint to corrode badly, in which case there will be a marked falling off in signal strength, and it may be difficult to

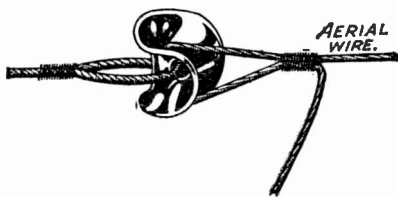

Fig. 2.—A better arrangement for connecting the down lead.

obtain oscillation on short waves. By far the best method is to avoid the soldered joint altogether in the way shown in Fig. 2. The aerial cable is passed through the

insulator, then bent back upon itself and bound with fine copper wire, as shown. A little solder may be run into the binding turns to make everything secure. In this way the aerial and the down-lead are made all in one piece.

Double Wire Aerials

But what is to happen in the case of double-wired aerials? Fig. 3 shows a good way of dealing with them. The first wire A is bent back upon itself and bound, as in Fig. 2, its length being sufficient to take it to the terminal of the lead-in tube. The other wire B is fixed in the same way to the insulator, but it is cut off rather shorter. The two are then soldered together at a suitable point. We have thus one wire continuous with the lead-in whilst the other is joined to it by a soldered connection. To make this connection soundly proceed as follows. At the place where the joint is to be made separate the wires of the down-lead by twisting them backwards. Then clean each separately with emery cloth. Unstrand the wire of B for about 2 in. Now solder each strand of B separately to a strand of the lead-in. Finish off by giving a good coating of stove enamel, and wrap the joint tightly with rubber tape.

The Down Lead

It is generally desirable that the down-lead should be insulated since as it swings in a wind it may make contact with the walls of the house or with the sides of the window frame. Enamel-covered wire has the great advantage in that the metal is protected from the effects of the weather, and therefore does not corrode. In soldering enamel-covered cable great care must be taken to see that every strand is properly cleaned before any attempt is made to use the iron.

The Lead In

Even if the down-lead itself is all that it should be there may be inefficiency in the aerial system owing to defects at the point of

entry into the house. One often sees the lead-in wire, usually none too well insulated, brought in by simply passing it through the open window, which is subsequently jammed down upon it.

Construction

With such an arrangement it will generally be found that long-distance reception is difficult to accomplish, and is not to be advised in any circumstances. An exceedingly efficient lead-in arrangement can be made in the following very simple way. With a $\frac{1}{4}$ -in. auger bit bore a hole through the woodwork of the window frame. Do not go right through from one side or you will split the wood away at the exit of the bit. As soon as its point shows remove it and complete the job from the other side. The result will be a clean-cut hole. Into either end insert a panel

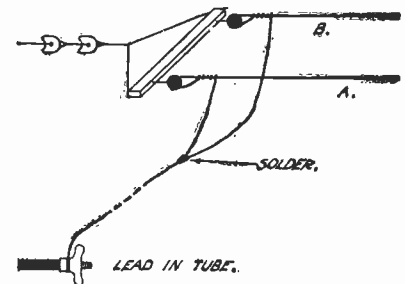

Fig. 3.—How the wire may be joined in a double wire aerial.

bush with a 2B.A. clearance hole. Cut off a piece of 2B.A. screwed rod 2 in. longer than the thickness of the window frame. Pass this through the bushes and provide it with terminal nuts at both ends. Wing nuts, which can be obtained in the B.A. sizes from any good tool shop, are better than the ordinary milled-headed type for securing the lead-in and the wire which runs to the aerial terminal of the set, for they can be secured very tightly with no great effort. Care must always be taken to see that both the end of the down-lead, which is attached to the terminal outside the window, and the terminal itself are quite clean. An occasional rub with a piece of emery cloth given to both will ensure that a good contact is made at this very important point.

R. W. H.

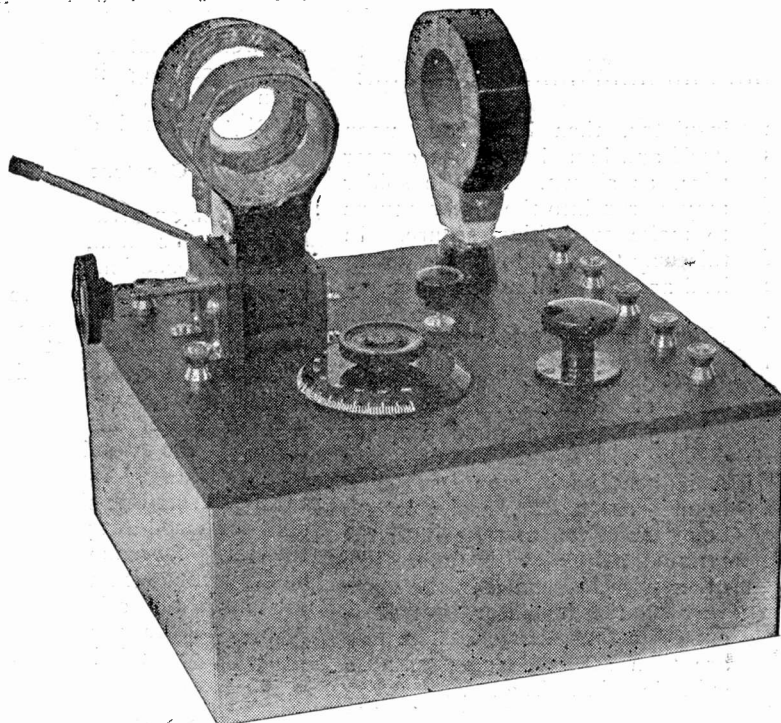

Fig. 1.—The Ultraudion circuit as constructed, the valve being beneath the panel.

THE receiver illustrated in Fig. 1 was made for the purpose of testing, with British valves and components, a circuit which is frequently put forward in American journals as excellent for general reception. The results show that its behaviour is so erratic, and its tuning so critical, that none but the more advanced experimenter would be able to obtain anything resembling satisfactory results; further, the circuit is so prone to burst into oscillation that unless handled with extreme care considerable interference can be caused to neighbouring listeners.

As to results, the receiver is just as sensitive as any good single-valve reaction set, but its principal attraction lies in the extreme selectivity which may be obtained; in fact, it may be said to be too selective for use by the average experimenter, the tuning of 2LO in a S.E. London suburb, for instance, being a very critical operation.

Practical Details

For those readers who care to try the circuit sufficient information will be given, though no

constructional details of the receiver itself will be published. The circuit as used is shown in Fig. 2, and will be recognised by the advanced reader as the Ultraudion. It will be seen that aperiodic aerial coupling is used whilst the secondary is tuned by a $.0005 \mu\text{F}$ variable condenser. The grid leak is variable, and it is essential that it should be so, otherwise the circuit will oscillate in such a way as to be out of control. In connection with this component, it is interesting to note that no less than four variable grid leaks of well-known manufacture were tried in the receiver illustrated, yet not one of them worked sufficiently well to give a satisfactory control of reaction. The fifth, which is incorporated in the receiver and doing useful work, may be seen in the photograph, and permits that fine control which seems to be so essential before any results can be obtained at all. C_2 is the usual grid condenser, and, after many substitutions, the best value found for this was $.0003 \mu\text{F}$ capacity. L_3 is a radio frequency choke consisting of a low-capacity coil of 250 turns.

Some Experiments with an Ultraudion Receiver

By STANLEY G. RATTEE,
Member I.R.E., Staff Editor.

Coupling Effects

By varying the coupling between the coils L_1 and L_2 , some mild control of reaction is obtained, though it will be found that in most cases there is an optimum coupling for each wavelength, any variation of which will at once cause signals to be lost, or else render them so weak as to be useless; in the same way the tuning upon the condenser C_1 is equally sharp, a variation of two degrees being sufficient to lose signals altogether.

Instability

Extreme care should be taken in choosing the valve, and various makes should be tried. In the writer's case, of the valves tried the most satisfactory, in so far as control was concerned, were the Cossor white top and Marconi R, with 4 volts as L.T. and 20 volts H.T. A French dull-emitter valve and also a Myers with 50 volts H.T. gave equally good results, with the peculiar phenomenon that increasing the H.T. to 100 volts in the case of the French D.E. did not seriously affect the general control of the receiver. It was found in all cases that the best results were obtained when the valve was working a little below its normal brilliancy. In the hope that the receiver would prove less critical, the secondary coil was earthed, but further experiments indicated that this connection did not affect the general disposition of

* * *

Some interesting notes on a popular American circuit which scarcely suits British Bright Emitter valves.

* * *

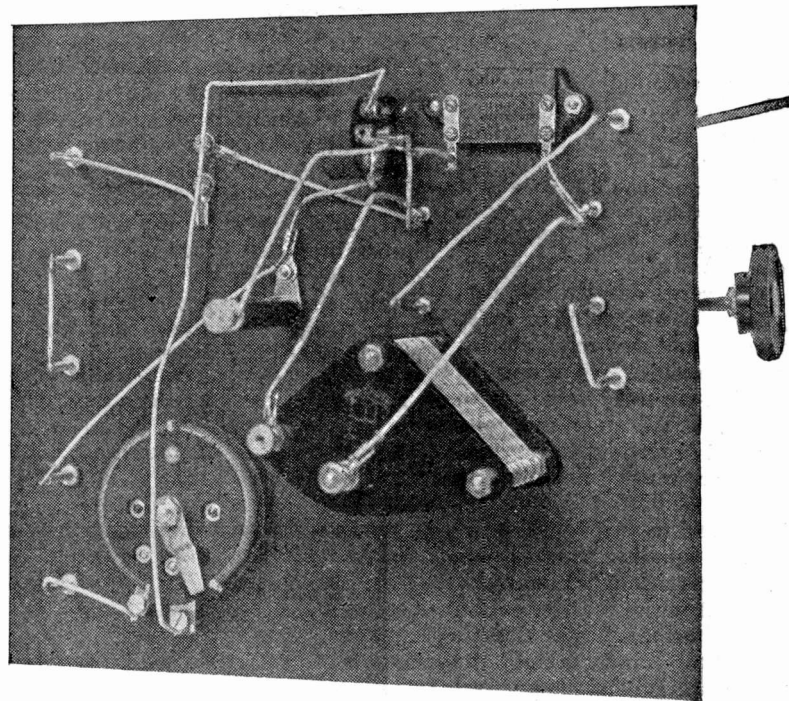

Fig. 3.—Back-of-panel wiring.

the circuit in the least. As a whole, the circuit proved to be quite sensitive, satisfactory signals being received from a number of distant stations both with an earth connection to the secondary and without it.

Stations received in S.E. London with this receiver were 2LO, 5WA, 5IT, 5XX, and Radio Paris, tuning being equally sharp upon all of them, and in no case was interference experienced from 2LO or any other station. The reception of London was accomplished, using a Marconi

appeared extraordinarily sharp, any attempt at tightening or loosening coupling losing signals altogether without the ability of retuning upon the condenser. Oscillation while tuned to this wavelength was very fierce,

was received from 5WA without a suggestion of interference from 2LO. The same peculiarity of optimum coupling was observed though the receiver showed a greater tendency to oscillate, control being again given by varying the value of the grid leak and position of the arm of the filament resistance.

Using a Cossor (white top) valve with the same batteries, the same reception of this station was obtained, though it was found that a considerable increase in the resistance of the grid leak was necessary before oscillation could be produced.

For the reception of 5IT it was found necessary to change the aerial coil (L_1) to an even smaller value, and a Gambrell a/2 was chosen with a B coil as secondary; subsequently the B coil was changed for a Gambrell C coil. Reception on this wavelength was even more critical than in the two previous cases, it taking some considerable time before any signals could be heard at all, though there was a better control of oscillation brought about, probably by the relatively slight increase in wavelength. Optimum coupling was again ob-

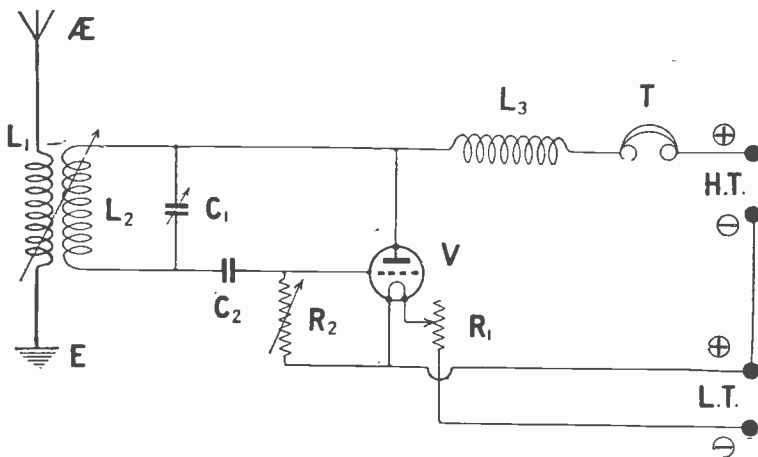

Fig. 2.—The circuit used.

R valve with 4 volts L.T. and 20 volts H.T., with a 25-turn aperiodic aerial coil (L_1) and a 75-turn coil for the secondary; reception was as critical as even the most fastidious could wish, whilst the optimum coupling of the two coils

though none the less controllable by varying the grid leak and valve brilliancy.

High Selectivity

Using the same valve, coils and batteries, quite the usual single-valve strength of signal

served both with B and C coils in the secondary circuit.

Valves

For the reception of this station both Marconi R and Cossor white top valves were tried, each with 4 volts L.T. and 20 volts H.T., and each gave about the same results with regard to signal strength and oscillation control. As a further experiment, a Myers dull-emitter was tried, but with any value of H.T. between 10 and 20 volts violent oscillation resulted. Using a French dull-emitter valve with 4 volts as L.T. and 45 volts H.T., good reception was obtained after much difficulty in controlling oscillation; the reduction of H.T. to 20 volts, however, gave equally good signals with a more reasonable control.

Compared with the reception of these shorter wave B.B.C. stations, the tuning-in of the long-wave station at Chelmsford was a simple matter, though none the less a tedious business.

Chelmsford

The coils for the 1,600-metre wavelength were a No. 100 for the aerial coil, with a No. 150 for the secondary, tuning being again sharp, with the same phenomenon of optimum coupling. Oscillation was fairly well under control, though not by any means perfect when using Marconi R and Cossor white top valves with 4 volts L.T. and 20 volts H.T., and French and Myers dull-emitter valves with 4 volts L.T. and 50 volts H.T., the grid leak again serving to control the tendency to oscillate.

Radiofa

Using the same coils as for 5XX, and the same valves with their respective voltages as before, Radio Paris was received at quite the usual strength one would expect from a single-valve reaction circuit, without interference from 5XX. Oscillation on this wavelength was slightly less marked than on 1,600 metres, though still very recalcitrant, whilst the optimum coupling effect was more critical.

During these experiments various values of choke (L3) were tried, but a No. 250 coil

seemed to satisfy all requirements in the best possible manner.

Other Tests

The receiver has been used by other members of the Radio Press technical staff in quite different conditions. Their results with it confirm my own. Should any reader care to try this circuit, it will be interesting to hear what success he has been able to attain, though it must be understood from the outset that the circuit is in no way advocated as being one suitable upon which to construct a receiver, the purpose

of this article being merely to convey to readers the benefit of another's experience.

In no circumstances is it suggested that any other than experimenters of long experience attempt to work this circuit on account of its tendency to oscillate, and so cause considerable interference; further, its tuning is such that only those readers who are familiar with sharply-tuned circuits, such as short-wave receivers, would in all probability be able to get any station other than the local broadcasting station, and even that with considerable difficulty.

ONGAR WIRELESS STATION

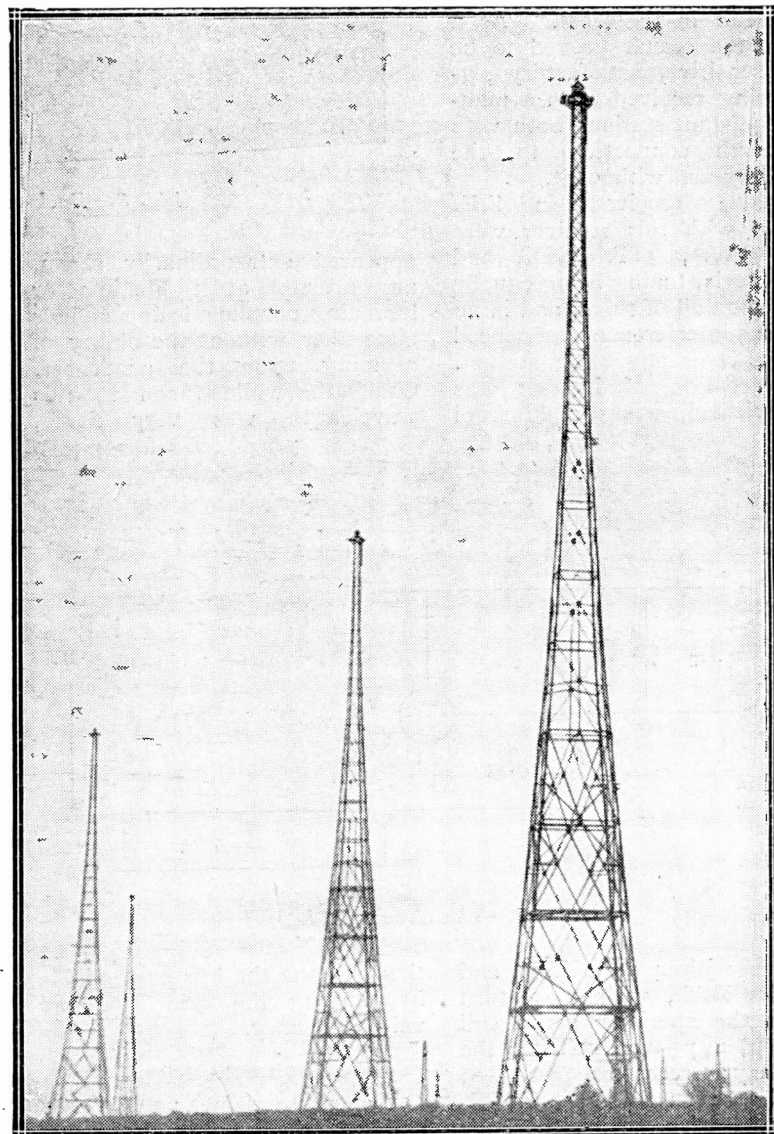

Our photograph shows the elaborate masts which support the aerial system at the well-known Ongar station.

Experimenting on Five Metres

By WILLIAM A. BRUNO.

In this article, which is a continuation of that published in the Vol. 5 No. 11 issue, the author, an American contributor, gives further details of his 5-metre transmitter, and the method of measuring the wavelength of such short waves.

ONE of the most important factors to take into consideration when building a C.W. transmitter for experimenting on very high frequencies is the length of the wires to be used for interconnecting the various parts, and the elimination of all

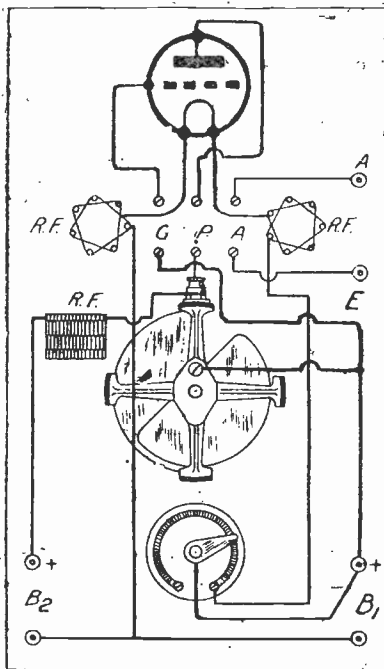

Fig. 1.—The back-of-panel layout of the 5-metre transmitter.

metal, not part of the circuit, from the immediate vicinity of the oscillating circuit.

Short Leads

The length of the connecting wires is very important for two reasons. First, every inch of wire introduces resistance losses. Second, if you use any more wire than is absolutely necessary, you are apt to be disappointed when you measure the wavelength of your set, as described in this article. You will remember how, in the first article, we described an experiment in which we absorbed the whole output of the transmitter with a small closed loop of wire, held near the oscil-

lator coils. This should prove to you the bad effect of any unnecessary metal parts anywhere in or near the transmitter.

Panel Layout

Fig. 1 is a layout of the rear of the panel. While other experimenters have suggested more compact forms, a great deal of appearance has been sacrificed, and we believe that this arrangement pleases the eye, while it is electrically efficient.

The coils marked R.F. in Fig. 1 are the three radio frequency chokes as described in the previous article, and A, P, and G are the aerial, plate and grid inductance terminals.

In the set built by the writer, provision was made to vary the coupling between the coils, but no use was made of this feature and at this writing these coils are about $\frac{1}{2}$ in. apart.

We assume that with the information given so far you have

been able to build this interesting outfit and are operating it successfully.

You certainly are wondering how these short waves may be measured. It is a well-known fact that these waves (and theoretically all radio waves) may be accurately measured with the ordinary yard-stick.

This statement seems amazing; still, it is very easily understood, once the theory of the travel of radio waves is considered.

Basically, we are dealing with an alternating current oscillating at a very high frequency.

We may represent the "rises" and "falls" of this high-frequency alternating current in the usual manner. (Fig. 2.)

We know that electricity travels at the rate of 186,000 miles per second, or 300,000,000 metres per second.

Now we will draw a line (Fig. 3) and assume that it is 300,000,000 metres long, or

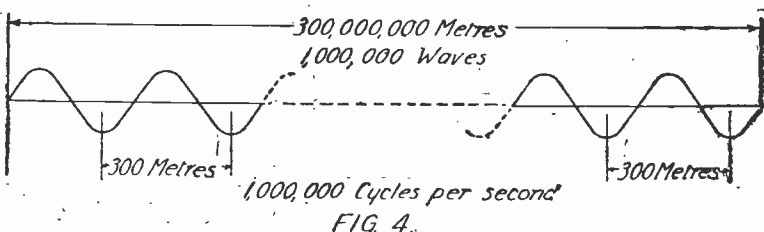
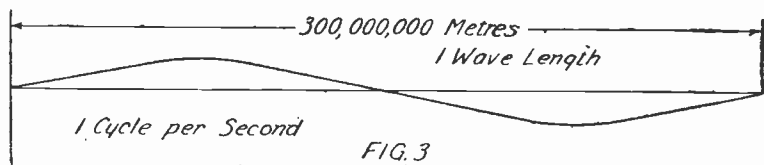
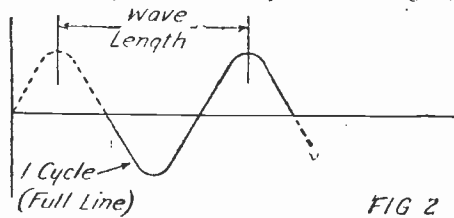

Illustrating the relation between the velocity, the frequency, and the wavelength of electric waves.

186,000 miles. (The distance ether waves travel in one second.)

Now assume that we are producing alternating current at a frequency of one cycle per second, and that this current is being radiated from an aerial. Each "peak" above the line in Fig. 3 would leave the aerial, and one second later would have

the following formula for frequency:—

$$F = \frac{300,000,000}{M}$$

Where F is the frequency and M the wavelength in metres.

In our case we are mainly concerned with the 5-metre waves and therefore show in Fig. 5 a

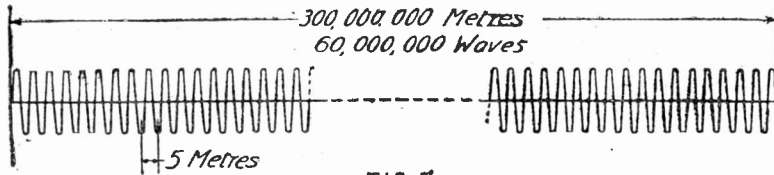

FIG. 5.

A pictorial representation of the connection between velocity, frequency and wavelength in the case of 5-metre waves.

travelled 300,000,000 metres away. At this instant, another "peak" would leave the aerial, travelling 300,000,000 metres behind the first one. The wavelength, or distance between these high spots as they travel away from the aerial, would then be 300,000,000 metres.

Then let us assume that we are able to increase the frequency of our transmitter until we are sending out 1,000,000 cycles, or 1,000 kilocycles in one second. Fig. 4 shows a line which we imagine to be 300,000,000 metres long (distance covered by ether waves in one second).

At this frequency, or any frequency, each wave still travels 300,000,000 metres away from the transmitter in one second. During this one second 1,000,000

hypothetical curve of a current oscillating at this frequency.

By referring to Fig. 5 you will

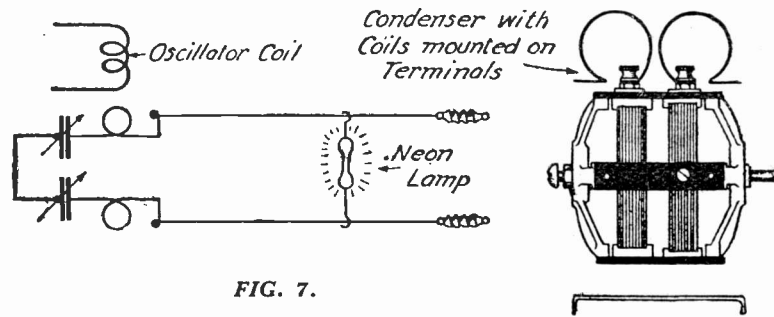

FIG. 7.

FIG. 7A.

Diagrams showing the apparatus used in measuring short wavelengths, and its arrangement.

note that at every $2\frac{1}{2}$ metres the voltage of the transmitted energy drops to zero potential.

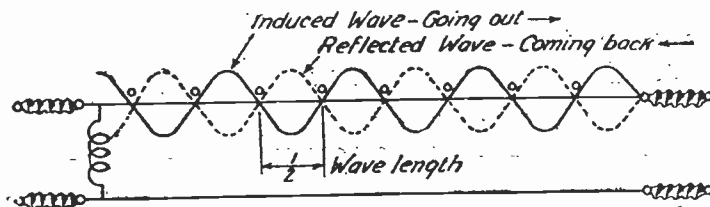

Fig. 6.—Showing the result of connecting a C.W. generator across two parallel wires.

more waves have left the transmitter, following the first wave. The distance from wave to wave, or the wavelength, then equals 300,000,000 metres divided by 1,000,000 waves, or 300 metres. By increasing the frequency of the C.W. transmitter, the waves leaving the aerial are crowded closer together, and the wavelength is shorter. Since 300 metres corresponds to 1,000,000 cycles per second, we can write

Now, then, if these waves could be made to stand still long enough for us to pick out the spots where the voltage was zero we could measure the distance from one zero-point to another, and get the wavelength with the famed yard-stick. Fortunately, such a method has been discovered, and takes its name from its inventor, Lecher.

Before describing this very interesting method of measuring

short waves we must delve again into the theory of oscillating currents.

Parallel Wires

If a C.W. generator is connected across a pair of parallel wires, carefully insulated, a wave will travel down the wires, and when it reaches the far end will be reflected back again. The result is shown in Fig. 6.

The zero point of each wave going out will always meet the same point of some other wave coming back at the points marked O. If, as shown in Fig. 6, the reflected wave is 180 deg. out of phase with the induced wave, then all voltages along the line are equal and opposite. If, however, the two are in phase, we shall get stationary waves of potential one half wavelength apart.

We are now ready to undertake intelligently the measurement of the waves generated by our miniature transmitter.

Run two parallel wires, about 25 ft. long, where convenient, 6 in. apart, and stretch them as tightly as possible. Attach good insulators at the ends of the wires and connect the two near ends to the dual condenser on which two single coils of wire 3 in. in diameter are mounted. (Fig. 7.)

Obtain from a garage a spark plug tester and remove the little lamp from its casing, being careful! not to break the wires nor to injure the lamp.

Use of a small Neon Lamp

This lamp is filled with neon gas and has the property of glowing when a high-frequency oscillation is applied to it. Place this lamp across the two wires and get the transmitter to oscillate. When the milliammeter shows maximum radiation, carefully

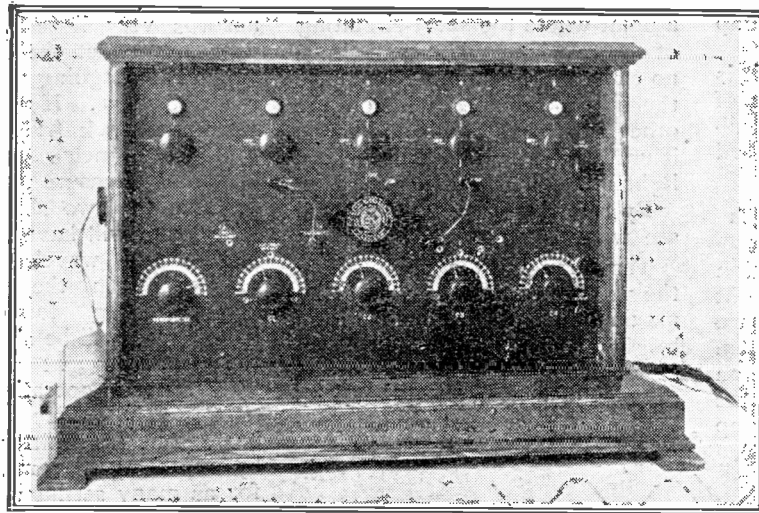

Fig. 1.—The "Super 5" receiver is of very handsome appearance.

THE sets about to be described have several interesting features. They have been on the market for some time and have stood the test of constant reproduction, there being, as a matter of fact, about a hundred in use at the moment. The complete set is no longer on the market, and, as the author has now the honour of being a member of the Radio Press staff, the results of research work on the

set are published in this paper, so that they may be generally available.

Separate Units

The portion known as the "Super 5" (Fig. 1) is a 5-valve receiver. The Super-Heterodyne, containing an extra four valves, can be plugged on to the standard set. The change over from the ordinary set to super-heterodyne occupies only

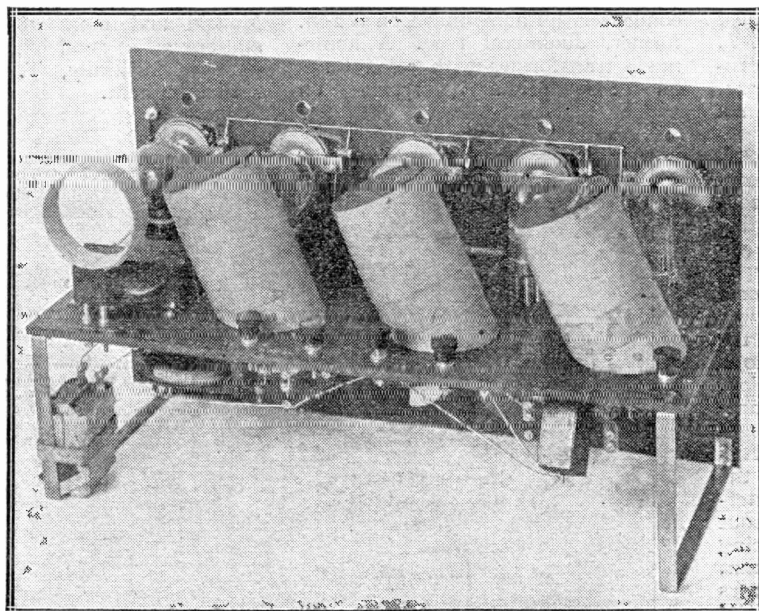

Fig. 2 shows the well-arranged layout behind the panel of the "Super 5" receiver. When this photograph was taken experiments were being made with transformer coupling for the L.F. stages, and Western Electric valves are shown.

A "Super 5" and a Super-Heterodyne Receiver

By R. TINGEY, Member I.R.E.

Mr. Tingey, whose name will be at once recognised in connection with the Radio Press Service Department, gives in the following article a description of a nine-valve super-heterodyne receiver. Full constructional details of how to build this super-set will be given in our next issue.

five seconds. No extra H.T. or L.T. is required.

We will consider first the "Super 5" receiver. When all valves are in use, we have two H.F., one rectifier, one transformer coupled L.F., one resistance coupled L.F.

Using any Number of Valves

By means of two wander plugs any number of valves, from one to five, can be used, also any combination of valves to suit any district. For example, near a local station the rectifier and one or two stages of low-frequency can be used. Further out one or two H.F. can be added. This switching method is efficient, as it is free from most capacity defects.

One Positive H.T. Tapping

Another feature is that the H.T. is not tapped, 120V being used throughout on both sets. This reduces the number of variables, but requires, of course, that suitable valves be used. The valves used are Cossor red top for H.F., Marconi R4B for rectifying, and Marconi LS5 for the L.F. valves. Actually in the photographs Western Electric valves are shown, these being used at the time the photographs were taken. So far as the H.F. valves are concerned, many makes serve equally well, but the use of the R4B for the rectifier is in itself a feature of the set. A large number of valves has been tried, but none comes near the R4B on this set for the purpose; 9 volts negative grid bias are used.

The H.F. Transformers

It will be seen the H.F. transformers are of special design, the directions of windings, angles and distances being of the utmost importance. They are plugged into sockets, and are interchangeable for different wavelength ranges. Oscillation and reaction are controllable in two ways:—

1. The potentiometer controls the 2 H.F. valves, and, owing to the arrangement of coils, the control *always* comes at about 160° — 170° out of 180° of the potentiometer, oscillation of the first two valves being produced near 180° .

2. The tuned circuit in the plate of the rectifier valve ("reaction"), when brought into tune with the wavelength being received, produces oscillation, so that by this means all valves may be adjusted to their best operating point.

H.F. transformer coupling is used throughout.

Use of Frame Aerial

If it is required to use a frame aerial the frame is plugged-in in place of the first "aerial transformer."

The theoretical circuit shown in Fig. 5 is "straight," the author being very keen on simple straight circuits, making each valve perform its one function, and that to its best advantage. In this way operation and control of many valves are simplified.

Signals come in with good L.S. strength using only three valves on an indoor aerial within six to eight miles of a main sta-

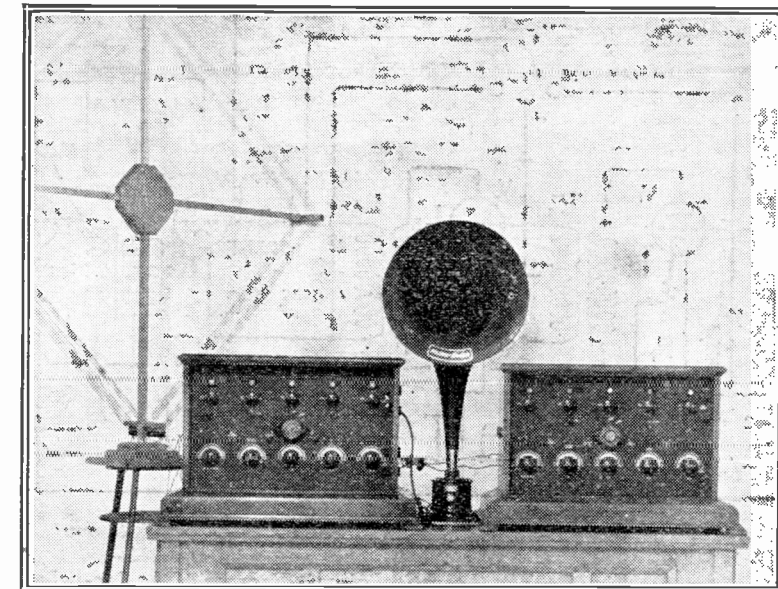

Fig. 3.—The "Super 5" together with the super-heterodyne, makes a very interesting and efficient installation. Note the frame aerial.

tion. On a frame aerial the results come in equally well. On an outdoor aerial the following results have been obtained by users of this set who are not wireless experts.

Results Obtained

Using all 5 valves on an indoor aerial in the Earl's Court, London, district, all B.B.C. stations have been heard on the L.S.

In Jersey, on an outdoor aerial, all B.B.C. stations were received easily, Bournemouth being best. Another Jersey man got WGZ and WHAZ on the L.S. At Newlands Cairns, Guildford, on 20-ft. wires thrown over bushes, using the car frame as earth, London (30 miles) was so loud it could be heard 200 yards from the L.S. in the open.

One of the chief charac-

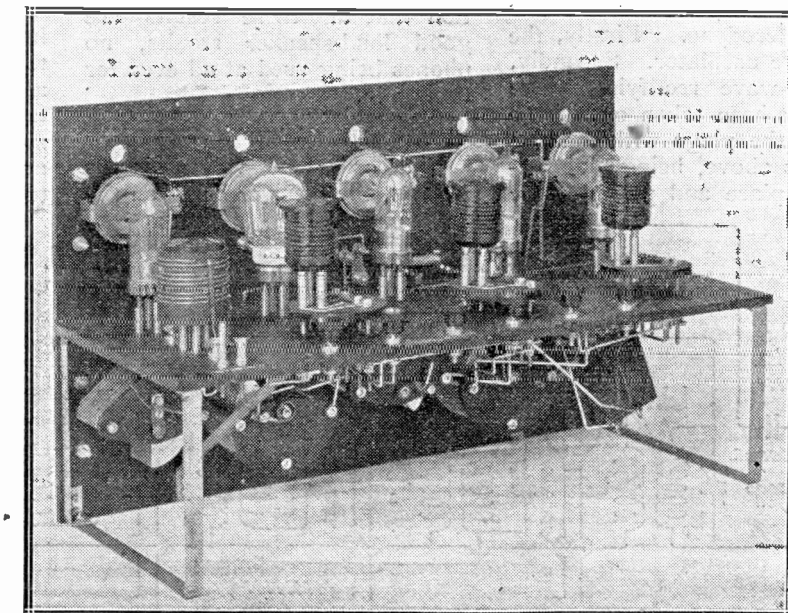

Fig. 4.—The back of panel arrangement of the super-heterodyne unit.

adjust the condenser in series with the long wires. When it is in resonance, the neon lamp will light up.

If you notice that the circuit is in resonance by the deflection of the milliammeter and the bulb does not light up, move it forward until it lights.

Method of Making the Wavelength Measurements.

Leave the bulb at the point on the wire where it seems to light up brightest. Now take two pieces of wire and shape them into a "bridge," as shown on Fig. 7A. Place one of these bridges on one side of the lamp

and move it backwards and forwards with a long insulated rod to a point where the short-circuiting of the two long wires will have no effect on the lamp. Now place the other U-shaped wire on the other side of the bulb and move it until the little lamp will merrily light up.

By referring to Fig. 8 we will see what is happening.

The lamp is at a point where the voltage of the waves is at its maximum, and the bulb glows brightly. The little bridges are at points where the voltage is zero, and consequently there is no tendency for current to flow

across, and no energy is absorbed by the bridges. The neon lamp absorbs very little energy, and does not affect the relation between the outgoing wave and the reflected wave. If you now take your yard-stick (ruled in metric system; 1 metre equals 39.37 in.) and measure the distance between the two short-circuiting wires, you will have exactly one-half of the wavelength of the oscillations in the wires. By applying the formula given before, you will be able to obtain the frequency at which your transmitter is operating.

It is very simple now to calibrate your transmitter condenser by repeating the measurements for as many settings of the condensers as you desire. The same applies to the wavemeter or resonator described in Vol. 5, No. 11. This calibration is very helpful if you wish to go on experimenting with short waves, especially when you will build a receiver for them.

In a future article we will discuss the method of "Keying" this transmitter.

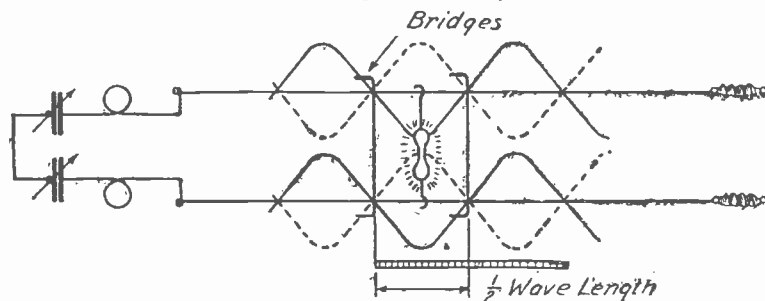

Fig. 8.—Illustrating the theory of the method of measuring short wavelengths.

A Reader's Results

SIR,—It may interest you to learn that I succeeded in almost uninterrupted reception of WGY, Schenectady, U.S.A., on the mornings of December 27 and 29, 1924, between 1.30 a.m. and 3 a.m. on a one-valve reflex circuit similar to Fig. 13 in *Wireless Weekly* dated December 26, 1923, with the exception of a loose-coupled aerial coil, also the phones were placed between L.T.+ and H.T.—. The reception on the 29th ult. was singularly free from atmospherics, Morse causing trouble by fading in three instances. With this exception the volume and clarity was equal to a good crystal set on the local station. A church service was being transmitted, and at 1.30 the congregation were singing "Noel." This was followed by a lesson from the 19th chapter — (here Morse interfered). The sermon lasted about twenty minutes, each word being clear and strong. Another hymn, then the organ played the "Stars and Stripes," after which WGY announced that they were going over to the Waldorf Astoria Hotel for band selections, which came through with no distortion whatever and faded only through Morse on two occasions.

Coils used, No. 25 aerial (parallel), .001 condenser, 35 grid,

.0005 condenser, 54 reaction, .0003 condenser, all home-made on a 2-in. former, duolateral type. A home-made transformer with 5,000 turns on the primary, 15,000 on

secondary, 47 gauge, enamel covered wire, was used.

Other results obtained cutting out Birmingham, situated only three miles distant. Le Petit Parisien, Brussels, Posts and Telegraphs, Madrid and most of the B.B.C. stations all at good 'phone strength. —Yours faithfully, T. G. BAGLEY. Birmingham.

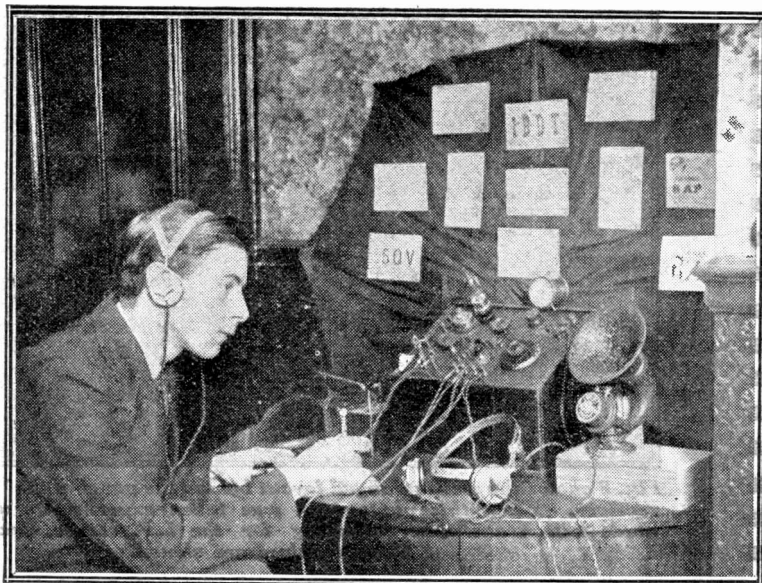

Our photograph shows Mr. T. A. Studley, of Harrow, who, using a one-valve set, has received Chili 9TC (situated near Valparaíso), and thirty-six American amateur stations.

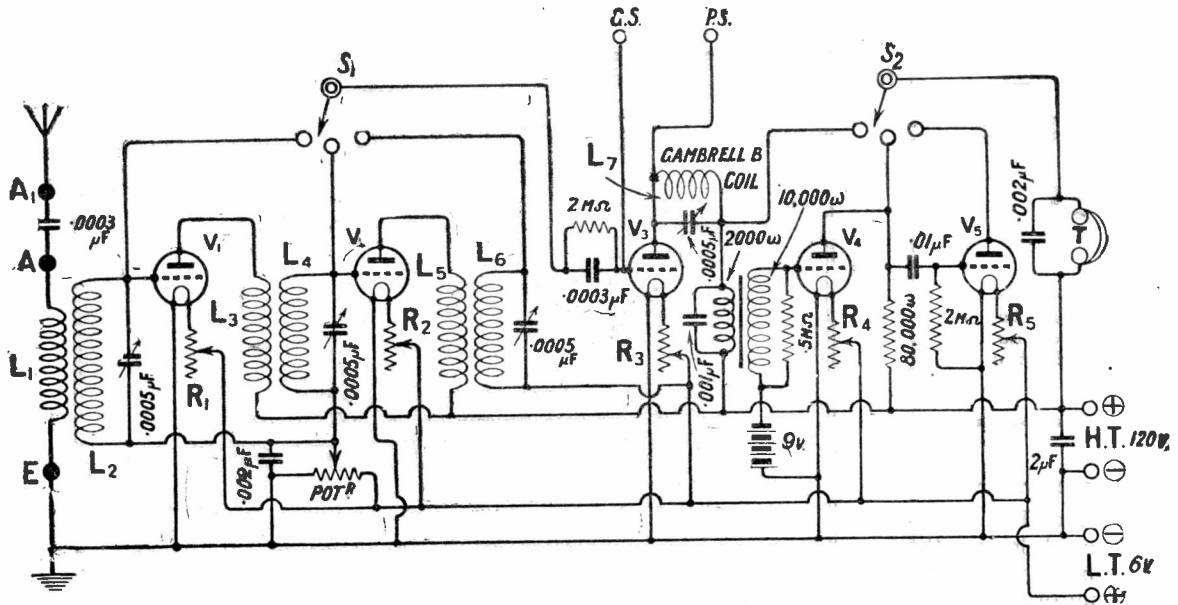

Fig. 5.—The theoretical circuit diagram of the five-valve receiver.

teristics is absence from noise, and there is a dead quiet background.

The Super-Heterodyne

Now we will consider the Super-Heterodyne.

There are five leads which are plugged into this set from the five-valve receiver—1, H.T. +; 2, L.T. - and H.T. - (common); 3, L.T. +; 4, a lead from the grid socket of the rectifying valve; 5, a lead from the plate socket of the rectifying valve.

There are 5 valves on the Super-Heterodyne. Firstly, the short-wave oscillator. Secondly, the short-wave rectifying valve which has been taken out of the receiver (the plugs with leads 4 and 5, as above, being plugged-in in its place and put into the

Super - Heterodyne). Thirdly, the long-wave high-frequency valves (two), and finally the L.W. rectifier, making a total of 9 valves in all.

Results

Constant results obtained on this combination on a frame aerial are all B.B.C. stations within 5 miles of the local station while the local station is working, all the usual Continental stations, and 3 American stations. It is well to mention that all these results are good loud-speaker results, no phones being used at all even for tuning in.

Valves

The order of valves is as follows, the receiver being on the

left, the super on the right: First on left, S.W. H.F.; second from left, second S.W. H.F.; second from right in Heterodyne, S.W. rectifier; first on right, oscillator; third from right, first L.W. H.F.; fourth from right, second L.W. H.F.; fifth from right, L.W. rectifier; third from left, plug; fourth from left, first note mag.; fifth from left, second note mag. You will notice that the S.W. H.F. and the S.W. oscillator are at extreme ends and so cause no interference with each other. In fact, a receiver working in the next room cannot hear the oscillation, even when an aerial is used—a great advantage. The signals in the first set thus work from left to right, and those in the S.H. from right to left. When using this

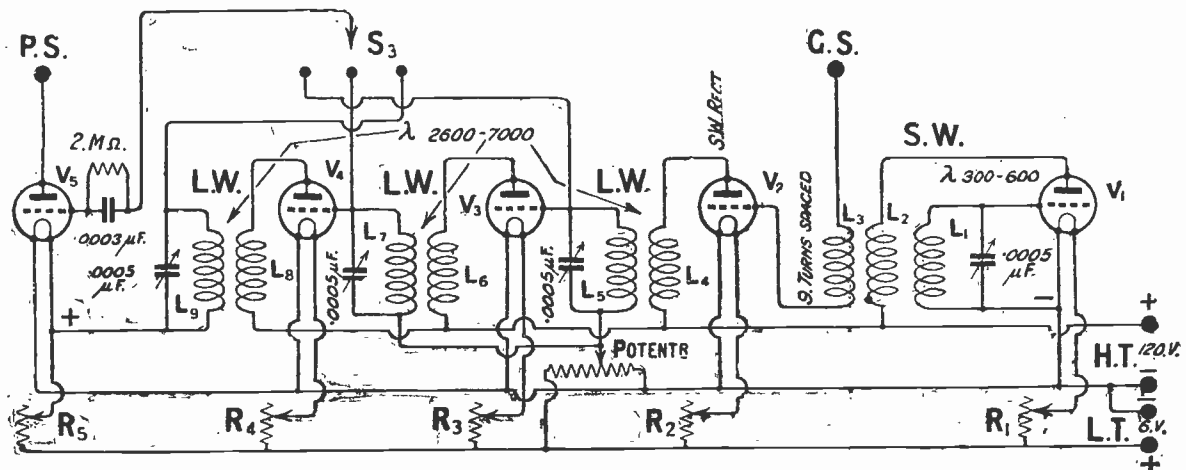

Fig. 6.—Theoretical circuit arrangement of the super-heterodyne unit.

method no elaborate shielding is necessary. The working of the Super-Heterodyne is as follows. The extreme right-hand valve is connected from both plate and grid to a plug-in transformer, the grid circuit being tuned. This oscillates, and around this transformer is placed a cylinder with about 9 turns of wire. The details of this were described in *Wireless Weekly* of November 26, 1924, page 201. A wire from the grid socket of the rectifier in the first set goes to these 9 turns, and so to the grid of the rectifying valve, which is now the second valve from the right in the Super-Heterodyne set. The next 3 valves are L.W., using M.H. transformers 2,500-7,000 λ tuned on their secondaries with .0005 μ F condensers.

The plate of the L.W. recti-

fier goes back to the plate socket of the S.W. rectifying socket on the "Super 5" set and so the currents are amplified at low frequency after passing through the closed reaction circuit, which, of course, now has to be L.W.

It is not necessary to have variable condensers on the L.W., but it makes it more flexible and enables L.W. to be received on it direct, and also allows one to counteract any variation there may be on the transformers.

The same plugging system is used on the Super-Heterodyne, enabling one, two, or three L.W. valves to be used as required.

The valve or valves not in use are turned out in addition to changing the position of the wander plug.

EDITOR'S NOTE. — Constructional details of this set will be published in a subsequent issue.

International Agreement on the Use of Call-Signs by European Broadcasting Stations

By Captain L. F. PLUGGE, B.Sc., F.R.A.S., F.R.Met.S.

The following are the salient points of a talk broadcast from 2LO on Jan. 8th.

AT present we count in Europe some 50 stations which I might term "regular broadcasting stations," inasmuch as they give a programme every day. Out of this number England stands first, both in the number of stations, in the continuous hours of transmission of each of these stations, and, I might also add, thanks to the efforts and enterprise put forward by the B.B.C., our broadcasting service stands very high for the quality and variety of programmes, and the importance of topical events transmitted.

The Programme Difficulty

However, as has often been said, it is difficult to provide a programme which will at the same time content a million people, and this difficulty is to be overcome in radio telephony by providing a choice of programmes from various stations. With the great number of sta-

tions at present working in Europe this condition is now satisfied, and, apart from interference which, with the education of the listener and the improvements made to transmitting and receiving apparatus, is getting less and less, it is possible for the listener with an efficient set to choose his own programmes.

Recognising a Station

There is one difficulty for the listener, however, and that is the difficulty of recognising the station to which he is listening. Some of the stations do not announce their identity more often than twice, once at the beginning and once at the end of a transmission. As in some cases these transmissions last up to three hours, it is often very difficult, apart from a special study, to recognise which station has been tuned in. I was recently visiting some of the Continental broadcasting sta-

tions, and I brought up the subject with one or two, and found that these stations were what I might call shy of giving out their names too often. They regarded it as a kind of advertising, and considered that it could be overdone. I think this was misplaced modesty.

Call Signs

Many stations have apparently no call sign allotted to them, but, on the other hand, some do announce their name more often than others. But, again, this name appears to be inconsistently allotted, as some stations use the name of a town, others the name of the company owning the station, and some a coined word derived from the company's initials.

Repetition

It ought to be possible for any listener to tune in any station and to know with certainty that after waiting a specified number of minutes he is going to know without doubt to which station he is listening. On the other hand, I am fully aware that the repetition of call-sign may become wearying to nearby listeners, but these will realise that the giving out of the call-sign is a necessity and that, if it were not given out, it would merely be replaced by a moment of silence; thus they are not losing any of the transmission because of the repetition.

Agreement Necessary

In America this repetition of call-signs is to-day a standard feature, and it is imperative that some such agreement should be reached in Europe. The use of call-signs is not the only method of identification. There are many ways by which this might be assured, but to me one thing appears definite, namely, that a standard method should be adopted.

With the increasing power used by Continental stations, the number of listeners tuning in these stations in England is great; yet I receive scores of letters from listeners who give me examples of programmes they have heard at definite times and dates, and ask me if I can identify the transmitting station. There is no doubt that this state of affairs must cease.

A Coil Testing Stand

THOSE who wind their own coils, as so many people do nowadays, must often feel the need of some means which will enable them to test the coils before they are mounted and finished off. Here is a simple little appliance which forms a most useful addition to the "gadgets" used in connection with the layout board described recently by the present writer in *Wireless Weekly*.

Constructional Details

Cut out a piece of any kind of wood $\frac{3}{8}$ in. or $\frac{1}{2}$ in. thick, making

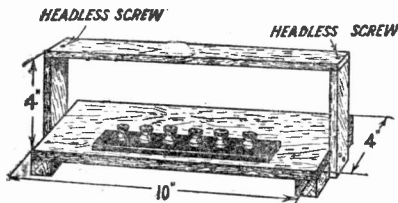

Fig. 1.—Shows the main dimensions of the wooden frame.

it 10 in. long by 4 in. wide. At the lower side fix two small battens so as to raise it about $\frac{1}{2}$ in. from the surface of the table. At either end fix an upright made of similar wood $\frac{1}{4}$ in. in height by

1 in. in width. Turn a screw into the top of each upright leaving about $\frac{3}{8}$ in. projecting, and cut off its head with a hacksaw. Next cut out a strip of $\frac{1}{2}$ in. ebonite 7 in.

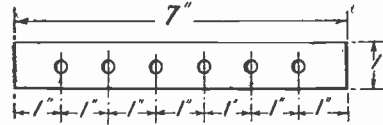

Fig. 2.—Details of the ebonite terminal strip.

long by 1 in. wide. Mark out and drill this, as shown in Fig. 2. The holes seen in the diagram are all 4B.A. clearance. Other holes of suitable size should also be made at the corners for the screws to fix the strip to the base of the coil stand. Fix the strip in position on the base making its front edge lie about $\frac{3}{4}$ in. from the edge of the base. Through each of the 4B.A. clearance holes pass the point of a scriber so as to make a prick in the wood. Remove the strip and drill a $\frac{1}{2}$ -in. hole right through the base at each point where a prick was made with the scriber. Now mount six terminals on the ebonite strip and fix it in position. The $\frac{1}{2}$ -in. holes will allow the nuts and shanks of the

terminals ample clearance. Cut out a hard wood strip 10 in. long by 1 in. wide and $\frac{1}{2}$ in. in thickness. Round off the edges carefully and drill in each end a hole through which the headless screw will just pass comfortably. The stand is now finished.

Method of Use

Fig. 3 shows the stand in use for testing a trio of newly-wound coils. They are simply threaded on to the horizontal strip which is easily removable from the uprights, leads being taken to each of the pairs of terminals. In this way a set of coils can be tested out on the wavelengths for which it is designed, so that any errors that may have been made will be discovered and rectified before

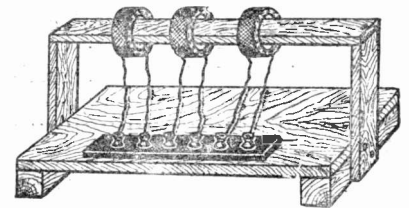

Fig. 3.—The complete stand.

finishing off and mounting are undertaken. The stand is also very handy for testing out the tri-coil circuits which have been described recently in *Wireless Weekly* and *Modern Wireless*.
R. W. H.

A VALVE holder may be usefully employed to link up both H.T. and L.T. batteries instantaneously to a receiver, as described in this article. Instead of the usual four terminals with which the set is

Valve Holders for Battery Plugs.

socket. The H.T. + is taken to one of the filament sockets and

valve pins, as shown, to suit the valve holder. Take the leads from the batteries to the pins corresponding in position to the sockets of the valve holder. To prevent accidents when inserting the plug into the socket, shorten the two filament pins, as shown.

H. B.

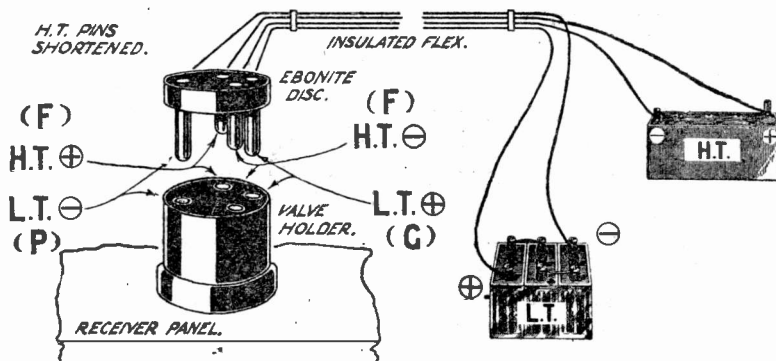

This pictorial diagram illustrates how the scheme is carried out.

equipped, mount a valve holder, as shown in the diagram. Take the L.T.+ lead to the grid socket and the L.T.- to the plate

the H.T.- to the other. Next make a plug from a piece of ebonite, $1\frac{1}{4}$ in. in diameter by $\frac{1}{4}$ in. thick and mount the four

OUT TO-MORROW!

The February issue of "The Wireless Constructor" will be on sale to-morrow. Do not fail to obtain your copy early. Your bookseller may be

SOLD OUT LATER!

Valve Mounting for Experimental Work

THOSE amateurs who do a considerable amount of experimenting with various circuits, etc., will appreciate a form of baseboard mounting for

meter of the hole through the bungs should be about 2B.A. clearance, so that when they are fitted into the holes in the baseboard the 2B.A. screwed rod is

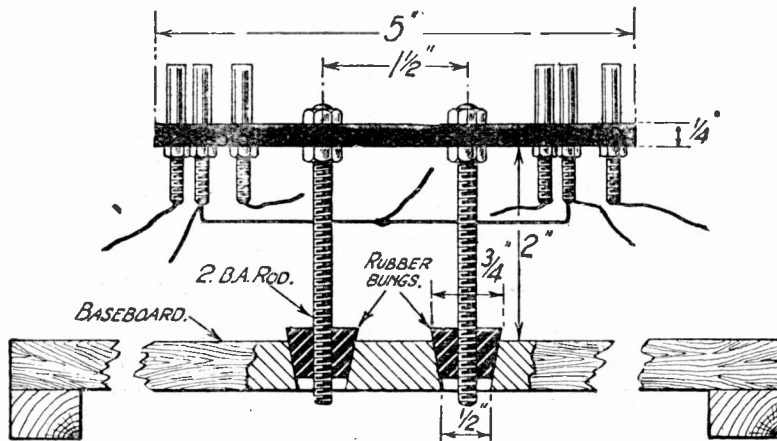

Fig. 1.—Constructional details of the valve mounting.

valves which will enable them to connect up rapidly one or more valves to various pieces of apparatus, and which will also help to lessen the shocks to which valves are often subjected in such cases, due to work being done on the same bench, or even to accidental knocking of the valves.

Mounting

The form of mounting to be described has also been found successful in reducing the unpleasant microphonic noises heard in the telephones when some types of dull emitter valves are used. As will be seen from Figs. 1 and 2, it consists essentially of a strip of ebonite upon which may be mounted valveholders, or simply valve sockets, this strip being supported by two lengths of 2B.A. screwed brass rods passing through two rubber bungs inserted into holes in the baseboard. The rubber bungs are of the type used in chemical laboratories, and should be fairly soft and flexible. They may be purchased already bored from most laboratory outfitters, and a No. 5 size (about $\frac{3}{8}$ in. diameter at the wider end) will be found suitable if $\frac{1}{2}$ in. holes are drilled in the wooden baseboard. The dia-

gripped firmly. No additional method of securing the rod to the rubber bungs is then necessary.

For supporting two valves the ebonite strip may be 5 in. by $1\frac{1}{4}$ in. by $\frac{1}{4}$ in. Holes are drilled

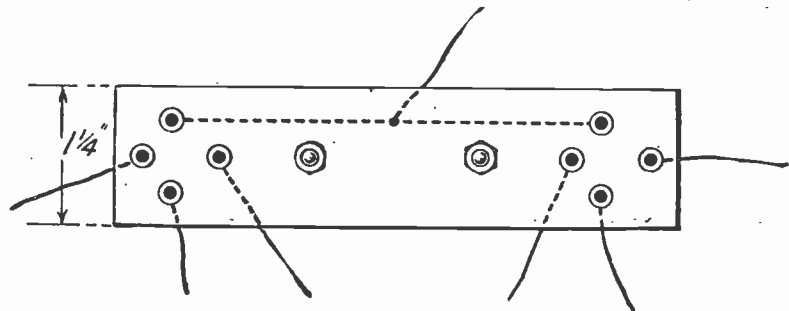

Fig. 2.—The ebonite strip showing how the flexible connections are made.

Drilling Templates

SIR,—Many firms now issue with their components a drilling template made of paper with full-sized holes punched in it. To find the exact centre of these holes so that one can mark the panel with a centre punch is something of a work of art. Would it not be of much greater value to their customers if these firms were to issue their templates with very small holes instead of full-sized ones, so small that

symmetrically near each end to take the valve sockets, and two holes $1\frac{1}{2}$ in. apart to take the 2B.A. rod.

Connections

Two of the shanks of the filament sockets, one from each valve, are connected by soldering to a piece of square section tinned copper wire. One end of a rubber-covered flex lead is then soldered to the centre, as shown in Fig. 2. (This lead will usually go to L.T. +.) To the shanks of all the other valve sockets flex leads about 4 in. to 6 in. long are soldered. These will usually be found of sufficient length in most cases. The reason for using flexible leads is obvious, since if more rigid wire were employed the advantages of the shock-absorbing mounting would be lost.

Any Number of Valves

The same method of mounting may be applied to a single valve or more than two valves quite easily; if, for instance, it is desired to mount four valves, the ebonite strip may be 10 in. or 12 in. long, the two supports being arranged between the first and second and the third and fourth valves.

D. J. S. H.

the point of a centre punch would just go through? The template could then be placed on the panel and the centres of the desired holes marked with the punch in a few seconds. If the templates were made of thin transparent material (celluloid), the template could be easily adjusted to existing marks on the panel.—Yours faithfully,

M. D.

Stafford.

Some Further Results Obtained with a "Two-Valve Receiver of Novel Design"

By JOHN W. BARBER.

Constructional details of this receiver, together with a short account of the capabilities of the set, were given in our last issue.

IN accordance with a practice frequently adopted by writers in Radio Press journals, the receiver, as described in our last issue, was tested by another member of the Editorial Staff, on a single-wire aerial, 60 ft. long, of average height 38 ft., in south-west London, about nine miles from that station. The first station to be received was undoubtedly German, operating on a wavelength slightly above that of the Brussels station, about 280 metres. Signals were received at very good phone strength, the music and speech being quite clear and free from distortion.

Breslau

Newcastle was the next station to be received, at moderate strength in the telephones. Interference and mush, however, spoiled reception, and so an attempt was made to receive some other station. This resulted in the reception, at good strength, of Breslau, and later, of Madrid, both with no interference from stations of the British Broadcasting Company.

Glasgow was the next station to be received, signals being fairly strong in the telephones. On this wavelength interference from ship and shore spark stations is usually troublesome, but on this occasion seemed less intense, thereby enabling the programme to be comfortably heard.

Loud Speaking

In most of the above cases, with the exception of Newcastle, the addition of the two-valve amplifier, referred to in last week's article, would have produced good loud-speaker results.

A further period of searching

on my own aerial, which, by the way, is not of a highly-efficient type, resulted in the reception of comfortable signals from the Glasgow station, and upon addition of the amplifier, the strength was all that could be desired. After the London station had closed down, a Spanish talk from Manchester was received, signals being perfectly clear.

5XX

Some tests were next conducted upon the experimental high-power station at Chelmsford, upon an evening when all the shorter wave stations were conducting a simultaneous programme, 5XX giving dance music from the Savoy Hotel. With the switch on the left-hand (long-wave) stud, this station tuned in at about 70 deg. on a .0005 μ F square-law condenser, using a No. 150 coil in

the aerial socket, with a Gambrell G in the reaction socket. A No. 250 coil may replace the G coil.

Some interference tests were then conducted, in the following manner:—The long-wave aerial and reaction coils were left in position, the switch being placed on the short-wave side. The anode circuit was tuned to resonance with the signals from 2LO, which were of good strength, when the aerial circuit was tuned to 5XX. In this position no interference from 5XX was noticed during transmission, but when music ceased at London for a minute, Chelmsford's programme could be heard faintly.

Selectivity

The switch was then put on the long-wave stud, and 5XX then came in at excellent strength, there being no trace of 2LO during the playing of an item, the anode oscillatory circuit being left tuned to 2LO. When an item from 5XX ceased, 2LO could be heard clearly, but not loudly. On detuning the anode circuit, signals from London were almost eliminated, and caused no interference during a quiet passage from Chelmsford.

It is thus clear that reception of Chelmsford or London may be effected without trouble, while for distant signals, good results may be obtained under quite average conditions.

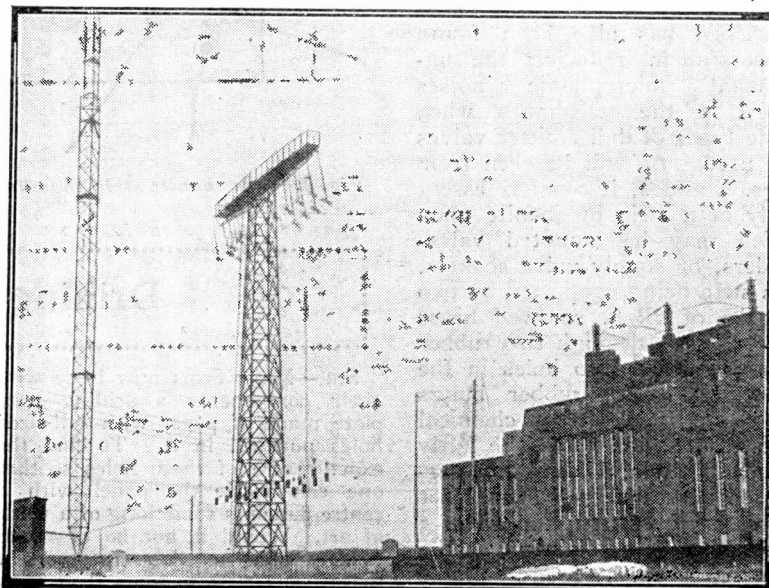

Our photograph shows the aerial system at the lead-in of the Nauwen Station.

Correspondence

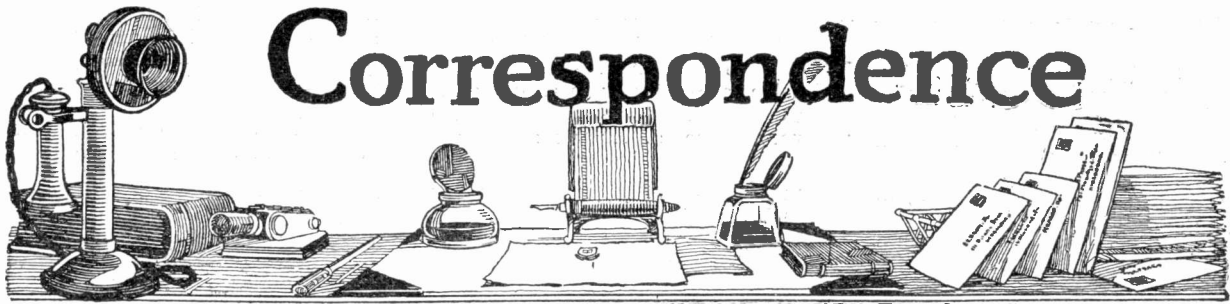

A SINGLE VALVE AT SEA.

SIR,—Being a regular reader of *Wireless Weekly*, I am wondering if the following would interest your numerous readers. From time to time I have noticed that not a few of my comrades in England get quite sarcastic about "test reports" and doubtless say to themselves: "If the guy who tested that set would come down and connect up to my aerial, he wouldn't get those results from 2LO, etc.," and what makes me smile is that these critics are, or rather should be, proud owners of two, three and in some cases four valve sets. Atmospherics seem to be a temper-damaging element in England; to quote one Cornish reader, "fearfully deafening noises." Well, to the few listeners-in out here they are constant com-

panions day and night, all the year round. When I can't hear them I start looking around for faulty connections, so after all atmospherics have their uses. I have had 5XX at good 'phone strength in Karachi and 2LO at 1,280 miles. I have been travelling around now on this East of Suez run for quite a while, and have managed to have the B.B.C. broadcast every evening in comfort, my eastern limit being Karachi. My set comprises just a single valve, straight circuit, with reaction on to the aerial. One and all are, I think, familiar with this circuit, so I will not waste time describing it. Here are extracts from my "log" for a recent night's transoceanic experiment, which was clearly received from 5XX.

10.45 p.m.—Captain Eckersley announces, "That's a very slow waltz" (heard quite plainly here).

10.49 p.m.—Capt. E. announces, "That's some atmospheric."

10.58 p.m.—Pittsburgh announces, "Switching over to Philii."

10.59 p.m.—Capt. E., "You will notice now they are switching over to Philadelphia."

11 p.m.—Philadelphia starts.

11.2 p.m.—C. E., "Someone oscillating badly." Capt. E. says he (the oscillator) is stupid; quite agree. Can hear him here.

11.3 p.m.—Dance music coming through well.

11.7 p.m.—Can hear oscillator howling plainly here.

11.11 p.m.—Philadelphia playing fox-trot. Capt. E. says, "Don't know about you, but I could dance to that quite easily."

11.18 p.m.—Capt. E. says, "Can't get a word in 'edgeways' here; they will go on." Philadelphia playing fox-trot.

1925

—make it "the best yet!"

It depends largely upon yourself. One very simple rule will make all the difference between radio success and possible failure. Don't expect to build an A1 set from C3 components; Say "ATLAS" and be safe. There isn't an "ordinary" component in the whole of the range. Many of the devices are patented, and in more than one instance the components are complimented by "the sincerest form of flattery."

Even if you don't as a rule believe in New Year resolutions, you will be glad you made this one:—I'll always ask for

CLARKE'S "ATLAS" SPECIALITIES.

For American Short-Wave Reception use Clarke's "ATLAS" Short-Wave Coils (Set of 4) incorporating the latest "Low-Loss" principles.

Sole Manufacturers:

H. CLARKE & CO. (Manchester) LTD.

Radio Engineers,
"ATLAS" WORKS,
OLD TRAFFORD,
MANCHESTER.
Phones: 683 & 793
Trafford Park.
"Grates": "Pitfold,
Manchester."

ATLAS

11.23 p.m.—The oscillator at it again.

11.25 p.m.—Philadelphia now playing "The Miserié" from "Il Trovatore" to fox-trot time (sounds excellent here). Capt. E. says, "It will go bad shortly."

11.29 p.m.—Capt. E. says, "It's gone bad—oh, very bad. Stand by a moment and hear what they've got to say; think they are switching to Pittsburg. There's the oscillator again."

11.31 p.m.—Capt. E. says, "There he is again," and gives a little homely advice about oscillators.

11.33 p.m.—Capt. E. says, "He hopes no one has been bored."

11.34 p.m.—Capt. E. says, "Good-night."

This is no freak reception; fading did not take place, although atmospheric to some would be "logged" as fierce. In time one becomes accustomed to such atmospheric and can sit and enjoy the broadcast through them. I sincerely think from the workings of this single valve set a little lesson could be taught, "that one valve properly handled is a match for a five-valve set haphazardly handled."

Wishing your valuable paper every success.—Yours faithfully,

"Ex. W. 74."
600 miles S.E. of Suez.

VALVE LEGS

SIR,—I was interested in reading Mr. Hood's method of mounting valve legs in order to reduce as far as possible their inter-capacity, in your issue of August 20, because some time ago I went very carefully into this question in connection with

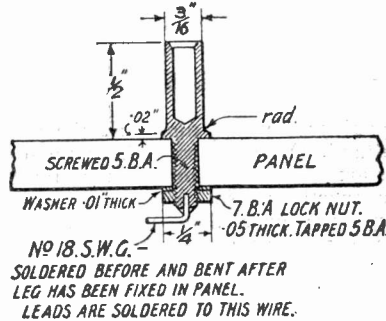

The arrangement suggested by Col. Dennis.

the use of four-pin valves in the original Transatlantic receiver.

Putting aside for the moment any reduction of capacity which can be effected by modification of the size and shape of that portion of the legs above the top of the panel—and a good deal can be done in this direction—it is clear that the best possible arrangement is to screw the legs into tapped holes in the panel. But

if this method is adopted there is serious risk of loosening the legs when the leads are subsequently soldered to them unless the precaution is adopted of soldering a short length of wire into a hole drilled in the stem of the leg, the soldering being done before the leg is screwed into the panel. The short length of wire should be bent, after screwing into the leg, in a direction away from the other legs, and the leads soldered to it.

The sole objection to this method is that, if lacquered legs are used, there is the difficulty of screwing them firmly home in the panel without scratching them or at least destroying the lacquer.

If the legs are to be inserted into a clearance hole and secured by nuts underneath the panel, I think that Mr. Hood will find that the minimum inter-capacity, consistent with reasonable strength, is obtained by the use of thin, small brass nuts and washers—lock nuts—made from lock-nuts and washers for a B.A. thread two sizes smaller than the standard nuts for the valve stem, tapped out.

Ebonite or fibre nuts, if used, would have to be very much larger in both diameter and length than the brass nuts referred to, and in using them the inter-capacity of the legs is increased in two ways which are apt

SELECTIVITY

Statement and Proof Q.E.D.

The immediate result of

LOW SELF-CAPACITY

Note the extraordinary LOW SELF-CAPACITY of "Tangent" Tuning Coils

(The Unshrouded Coil)

and you will realise their extreme SELECTIVITY and EFFICIENCY

NATIONAL PHYSICAL LABORATORY SIGNED REPORT

Self Capacity in Micro-Microfarads	Coil No.	Price.
8	25	4/3
9	35	4/3
25	50	4/3
31	75	4/6
22	100	5/-
16	150	6/-
22	200	7/-
22	250	7/6

Complete Sets:—
4 Concert Coils (W/L 250-1070) 16/- the set.
11 Concert Coils (W/L 250-8750) 67/- the set.



Ask your dealer for "Tangent" Coils and add 30% volume to your present reception and also cut out your local station.

GENT & Co., Ltd., Faraday Works, LEICESTER. Est. 1872.

Manufacturing Electrical Engineers,

London: 25, Victoria St., S.W.1 Newcastle-on-Tyne: "Tangent House," Blckett St.

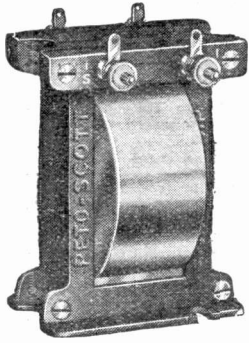

Peto-Scott Square Law Condensers

Solid ebonite end plates. A true straight reading. Two-piece self-centring dial. One-hole fixing to panel.

- Prices:
- .0001 mfd. .. 7/-
 - .0002 mfd. .. 8/6
 - .0003 mfd. .. 10/-
 - .0005 mfd. .. 10/6
 - .0010 mfd. .. 11/6
 - Dual Condenser (each half .0003 mfd.) .. 15/6

The new Max-Amp

The wonderful Max-Amp Transformer has recently been redesigned and is now supplied totally enclosed in a stout metal shroud. For high amplification combined with a complete lack of distortion the Max-Amp is unrivalled. Technical readers should note that its primary is wound with silk-covered copper wire—that its laminations are completely insulated and not pierced by any bolts—that every Transformer carries a 12-months 19/6 guarantee—that the price is only ...

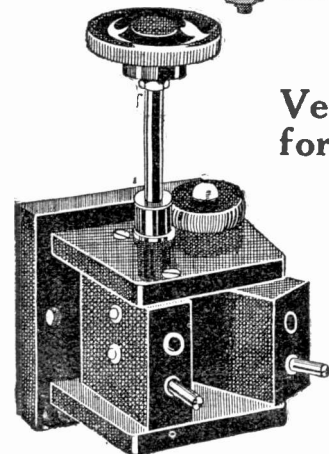
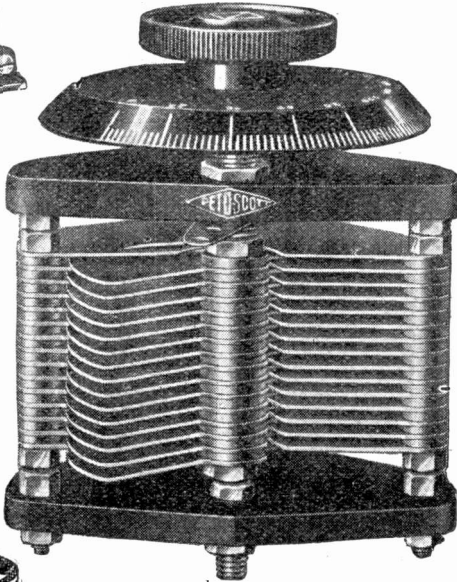

Vernier Coil-holders for 2 or 3 Coils

An excellent idea. Each moving coil driven by friction movement. Delicate adjustments easily obtained. Illustration shows only 2-coil holder, but same method is employed in 3-coil holder. Made from solid ebonite beautifully polished.

- Prices: .. 2-coil holder .. 10/6
 .. 3-coil holder .. 17/6

Send 3d. at once for our 48-page illustrated Catalogue, essential to every experimenter, Post free 3d. Peto-Scott's Wireless Book contains over 80 circuit diagrams and much useful information. 1/3 (post free 1/5).

Red Triangle Ebonite

As specified by Radio Press and used frequently in "Wireless Weekly," "Modern Wireless," and "Wireless Constructor." Fully guaranteed free from surface leakage. Supplied in 16 stock sizes, 1 in. thick at 4d. per square inch, with velvet matt finish and ground edges. Don't risk using a cheap and unknown ebonite or substitute, but send your order at once for a Red Triangle Panel. Delivery by return.

Special Radio Press sizes:

All Concert de luxe	16 x 8 x 1/4"	8/-
Transatlantic V	22 x 11 x 1/4"	15/-
All Britain	16 x 9 x 1/4"	9/-
ST. 100	12 1/2 x 9 1/2 x 1/4"	7/-
Harris Crystal Set	9 x 5 1/2 x 1/4"	4/4
Puriflex	14 x 10 1/2 x 1/4"	9/2
Resistoflex	12 x 8 x 1/4"	6/-
Transatlantic 4	16 x 8 x 1/4"	8/-
Anglo-American	36 x 9 x 1/4"	20/-

Packing and Postage 6d. per panel extra.

PETO-SCOTT CO. LTD.

Registered Offices:

77, CITY ROAD, E.C. (For all Mail Orders).

Branches—LONDON: 62, High Holborn, W.C.1; and 230, Wood Street, Walthamstow. CARDIFF: 94, Queen Street. LIVERPOOL: 4, Manchester St. PLYMOUTH: Near Derry's Clock.

P.S. 2086

It will pay you always to watch WIRELESS WEEKLY Advertisements.

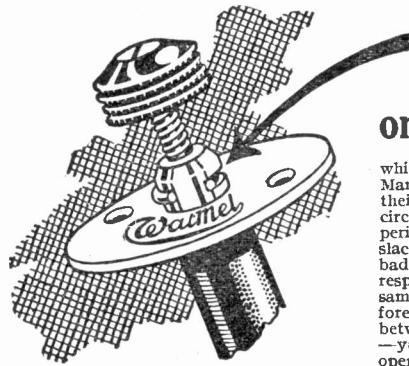

It's the refinement on the plunger!

which makes the difference. Many mysterious noises have their origin in the detector circuit. After considerable experiment we discovered that slackness of the plunger causing bad or intermittent contact was responsible for them. This same slackness permitted foreign matter to house itself between the collar and plunger—yet another cause of noisy operation.

The WATMEL therefore is now designed to obviate this trouble. A small but strong spring is recessed through the collar and compresses on to the plunger. This device ensures good contact. Slackness is automatically taken up, and the point of contact is always bright and clean.

The advantages of the Watmel Variable Grid Leak, incorporated in the Detector panel, are already well known. The addition of the compressing spring makes the WATMEL, super-excellent for assisting detection.



All goods of our manufacture bear this mark. It is your only guarantee.

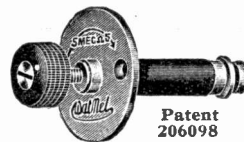

- Patent 206098
- 5 to 5 Megohms ... 2/6
 - 50,000 to 100,000 Ohms 3/6
 - Other Resistances to suit any circuit.

Send P.C. for Descriptive Folder. SEE THE TRADE MARK



ON EVERY GRID LEAK. BEWARE OF IMITATIONS.

WARNING!

The Watmel Wireless Co. wish to notify the trade and public that their Variable Grid Leak Patent Application No. 206098 was contested in the Comptroller's Court, and on Appeal; in both instances the Patent Grant was upheld and costs awarded.

It is the aim of this Company to protect traders', customers', and also its own interests by securing Patent protection for the novelties in its specialities, as it is these novelties, invented by experts and exhaustively tested, which are the Hall Mark of all Watmel Products.

THE WATMEL WIRELESS CO.

332a, Goswell Road, London, E.C.1.

Telephone - - - - - CLERKENWELL 7990.

AMPLIFY WITHOUT VALVES

BY THE AID OF THE

"DETECTAVOX"

Can be clamped direct to the earpiece of a CRYSTAL RECEIVING SET. A supersensitive instrument that really does what is claimed for it. Price 17/6. Accessories needed are Transformer, 17/6, and 3-volt Dry Battery.

Our 44-page New Radio List illustrates this and hundreds of other Radio Components. Send 4d. in stamps and secure a copy at once.

ECONOMIC LTD. | Head Office: 10, FITZROY SQUARE, LONDON, W.1. | Showrooms: 303, EUSTON RD. N.W.1

THE LARGEST and MOST PRACTICAL WORK OF ITS KIND IN THE WORLD

“APPLIED ELECTRICITY”



Very much reduced.

EIGHT VOLUMES, MEASURING 5 by 8 inches

WRITTEN AND COMPILED BY 28 SPECIALISTS, AND CONTAINS 4,100 PAGES, 3,300 ILLUSTRATIONS, TABLES, WORKING DIAGRAMS, ETC.

The Electrician will find in these books a veritable mine of information. He will not have to wait until he is put on a job before he can learn something of it: "APPLIED ELECTRICITY" will teach him ALL about it, and all about every other job in the industry. The working Diagrams, Tables, Blue-Print Inserts, to be found in the books will be of intense practical value to him when actively engaged, and will ensure accuracy. To the Student these books will give a wide, general insight into the Electrical Industry and will help him to decide which branch to enter. They will teach him how to study for a position and will provide the matter to study.

Student and Electrician, Novice and Experienced Man, will all find in these books much that they would never have known by years of practical experience alone.

SOME of the CONTENTS

BLUE PRINT INSERT A SPECIAL FEATURE

Elements of Electricity—Principles of Direct Current Machinery—Commercial applications—Alternating Current Machinery—Electric Power Systems—Armature Windings—Alternators—Steam Turbine-Driven Alternators—Economy Factors in Alternators Rating and Overload Capacities—Alternating Current Testing—Ideal Transformer Action Graphically Represented—Conversion of Alternating into Direct Current—Design of D.C. Dynamos—Classes of Armatures—Winding Tables for Armature Windings—Design of Small Motors—Illustrating Diagrams changing Characteristics of Motor by Rewinding—Automobile Starting and Lighting Equipment—Design of 10,000-volt Transformer—Electrical Measurements and Meter Reading—Electric Elevators—Railway Signalling, etc.

WHAT OTHERS SAY

22/9/24.

"I am in receipt of your Cyclopaedia of 'APPLIED ELECTRICITY,' 8 volumes, and I may say that I am absolutely delighted with them, and with the manner in which the study of Electricity is explained with careful detail. I myself have passed a B.Sc. Course in Electrical work, but I find that your books convey things to me much better than any I have already seen."

SEND THIS COUPON NOW

PARTICULARS FREE

A booklet has been prepared dealing with the possibilities of the Electrical Industry and describing the contents of "APPLIED ELECTRICITY." It also contains a specimen Blue-Print Insert.

Write a simple request on a postcard, or fill in and send to us the form below, and we will send you a copy free of charge and any obligation to purchase the books.

FILL IN THIS COUPON AND POST IT NOW. IT PUTS YOU UNDER NO OBLIGATION

SALES DEPT.

The American Technical Society,
42, Theobald's Road, P.O. Box 147,
LONDON, W.C.1.

Dear Sirs,—

Please send me a FREE copy of the booklet describing "APPLIED ELECTRICITY" as published in eight volumes, its price and terms of easy payments.

Name.....

Address

W.A.V.

Wireless Weekly Small Advertisements.

SETS wired up to order. Best workmanship. One-valve set, 7/6.—W. W. Penn, 8, Craven Walk, N.16.

5-VALVE Transatlantic complete with valves, coils, transformers. Particulars on application.—Box 27, "Wireless Weekly," Bush House, Strand, W.C.2.

3-VALVE Set in handsome polished sloping cabinet, work loud speaker, receive all B.B.C. Stations, Continent, America, etc. All accessories included. Valves, Accumulator, H.T. Battery, Lead-in wire, Aerial wire, Insulators, Headphones. This set is in perfectly new condition, and guaranteed to give absolute satisfaction. A genuine bargain. £8 15s. Seen and demonstrated any time.—Burroughs, McDermott Road, Peckham, London, S.E.15.

PARTNERSHIP offered to keen wireless enthusiast willing to invest £50, with or without part-time services, in a business dealing with wireless inventions.—Box A 19, "Wireless Weekly," Barclay's, Bush House, W.C.2.

PATENTS AND TRADE MARKS.—Inventor's Advice, Handbook and Consultations free.—B. T. King, Registered Patent Agent, 14Ca, Queen Victoria St., London, Phone: 682 Cent. 39 years' experience.

AGENTS Wanted.—Wireless valve repair business. Deal with the actual repairers. Lowest grade terms. All types repaired. A hard vacuum guaranteed. Also old valves bought for cash, 9d. each. Cossors, 1/- each.—M. & G., 60, Churchfield Road, Acton, W.3. Telephone Chiswick 2681

TELEPHONE RECEIVERS and Loud Speakers Rewound, 2,000 ohms, 3/6.—A. Roberts & Co., 42, Bedford Hill, Balham, S.W.12.

HEADPHONE REPAIRS. — Rewound, remagnetised, readjusted. Lowest prices quoted on receipt of telephones. Delivery three days. Est. 26 years.—Varley Magnet Co., London, S.E.18.

To make your Amplion Junior equal to a five-guinea model in tone, volume and appearance write Maddison, Wood Horn Mfg., 2a, Ronalds Road, N.5.

EXCEPTIONAL OPPORTUNITY FOR REAL BARGAINS.

	£	s.	d.
New Magnavox Loud Speaker	-	-	4 5 0
New Cosmos Crystal Set	-	-	1 8 0
Brown's A type phones, 120 Ohms	-	1	2 0
3-valve Mark IV Amplifier	-	-	4 0 0
3-valve Aircraft Receiver	-	-	3 17 6
3-valve Aircraft Receiver with 5 new V24 valves, remote control	-	-	13 0 0
Mark III Tuner complete	-	-	5 0 0

Carriage paid anywhere in U.K. Approval.

ASHBOURNE, 108 Moorland Rd., STOCKPORT.



PORCELAIN
Reversible Valve Holder.
One-hole fixing, above or below panel. 1/3 each.

COIL MOUNT. With the Perfect Plug. 1/- each.

ATHOL ENG. CO.,
Cornet St., Hr. Broughton, Manchester.

DIALS WIRELESS SCALES
NAMEPLATES PANELS & LABELS

ENGRAVING
OF EVERY DESCRIPTION

THE TRIUMPH ENGRAVING CO
10 OLD COMPTON ST LONDON W1

—PARIS AND OTHER STATIONS—
Clearly heard on Loud Speaker Nr. London using the "MIRACLE" MASTER 2-Valve Set. £3-12-6 plus Royalties. 1, 2, 3 & 4 Valves. Trade Supplied. Send stamp for particulars. WORLD'S WIRELESS STORES, Wallington.

to be overlooked, viz. :—(1) By the necessity of having a much greater length of the screwed part of the leg projecting below the under side of the panel; and (2), by introducing between the under part of the legs a mixed dielectric having a much higher mean dielectric constant than air alone.

I attach a rough sketch of the method of attachment of the legs which I adopted after careful trial. The flange on the valve leg might be considered superfluous at first sight, but it was found necessary in order to prevent the leg from bedding into the ebonite when screwed hard up; and as it is only of the same diameter as a standard valve leg, and very thin, the added capacity is inappreciable. The nuts and washers are also as thin as possible.

The chief object of this letter is, however, to point out the fallacy of the ebonite nut.—Yours faithfully,
MEADE J. C. DENNIS, Col.
Co. Wicklow.

INTERESTING EXPERIENCES

SIR,—The following experiences with a home-made five-valve set should be of interest to your readers. The circuit used is quite straightforward—aerial circuit is variometer tuned, two H.F. valves are employed with tuned anode coupling. Two P.A.2 power valves

with 200 volts H.T. follow the detector.

Some time ago I remember reading in *Wireless Weekly* an account of some experiments with shrouded transformers showing that the alleged screening effect was not all that was to be expected.

Here is an interesting effect that was observed the other day which reminded me of the article I had previously read.

The writer was giving a demonstration at a club. Not satisfied with the volume obtained and with the hope of making a big noise, a commercial four-valve set was rigged up and a two-valve power amplifier added, followed by a Magnavox Junior. An Amplion loud-speaker was connected to the "phone" terminals of the set so that by means of a switch it was possible to change over to the Magnavox with its power amplifier. In addition to this, there was a switch for connecting the output terminals either after the detector, first L.F. valve or second L.F. valve.

When a station was tuned-in on the Amplion the change-over switch put the Magnavox and amplifier in operation, with the result that a colossal L.F. howl commenced. Cutting out a valve made little difference, and the howl only

stopped when the power amplifier followed the detector.

The remarkable thing is this. The Amplion was switched on again following the four-valve set. It happened that the power amplifier was left with the valves alight. Imagine my surprise when listening near the Magnavox to find that it was also reproducing music, the volume being nearly as great as that of the Amplion! This meant that the magnetic coupling between the four-valve set and power amplifier must have been strong, in spite of the fact that the transformers of the amplifier were over a foot away from those of the set, and in addition, were enclosed in steel cases which were "earthed." (In fairness to the transformers, it should be mentioned that the wiring from the set to the amplifier was not carefully carried out.)

Although the transformers in the set are not shrouded and the cores are not "earthed," one would not have thought that two shrouded and "earthed" transformers of excellent manufacture following even one of these and placed over a foot away from it would have picked up sufficient energy to work a loud-speaker at moderate volume!

Trusting that some of these experiences may benefit others. I think that by comparing each

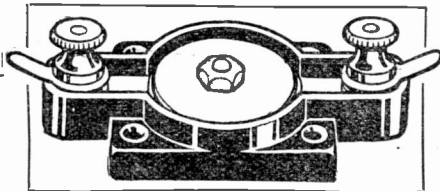

FINSTON FIXED CONDENSERS

are symbolic of Stonehenge because of the everlasting qualities which serve to make them immune from trouble in the most exacting and protracted use. They stand the test of time.

Guaranteed within 5% of stated capacity. This accuracy has never before been obtainable by the public. Buy one. Test one. It will prove our statements and thoroughly satisfy you.

FEATURES:
Reliability of Capacity. Finest grade Mica Dielectric. Highest possible quality Copper Foil. Adapted for Terminal or soldered connections.

CAPACITIES:
.001 to .0005, price 1/3 each.
.002 to .006, price 2/- each.

If your dealer cannot supply Finston Components, send your order to us together with his name and address, please!

LIGHTING SUPPLIES CO.

2, FINSBURY AVENUE, LONDON, E.C.2



HAWK COILS

MAXIMUM

MINIMUM

Efficiency

Capacity

Strength

Damping Effects

Resistance

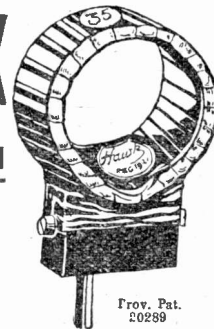

Prov. Pat. 20289

WATERPROOF

Prices below

Coil	Wave Length using .001 Variable Condenser in Parallel		PRICE.
	MAXIMUM	MINIMUM	
13	—	—	2/-
25	395	190	2/4
30	435	240	2/4
35	515	360	2/6
40	680	370	2/8
50	835	485	3/-
75	1250	600	3/4
100	1820	815	3/10
150	2300	960	4/8
200	3100	1370	5/4
250	3750	2200	5/8
300	4500	2300	6/-
400	4950	2500	6/6

Sold by all Wireless Dealers

Sole Manufacturers

The Hawk Coil Co., 39, PENRHYN RD., Kingston-on-Thames

other's observations we can best progress.—Yours faithfully,

A. D. TROUNSON.
Redruth, Cornwall.

BROADCASTING AND ADVERTISING

SIR,—I am afraid that I cannot agree with many points in your editorial in the December 31 issue of *Wireless Weekly*.

With regard to the fact that a newspaper or a large stores may offer to provide a complete evening programme, such offer cannot possibly be classed as advertising by the B.B.C., provided that the names of the firms concerned are not mentioned in front of the microphone.

Personally, I consider this to be one of the finest ways of raising the standard of the B.B.C. programmes in general, which is no doubt what every listener desires.

Let the people providing the programme advertise it to their hearts' content, and then I cannot see any reason for accusing the B.B.C. of breaking its rules and conditions.—Yours faithfully,

EDGAR M. DENT, F.R.C.O.
London.

[Other readers' views are invited.
—Ed.]

A SINGLE-VALVE RECEIVER FOR BRIGHT OR DULL EMITTER VALVES

SIR,—I am writing to congratulate you on the excellent single valve set which was described by Mr. Stanley G. Rattee in *Wireless Weekly*, Vol. 4, No. 24.

We are situated thirteen miles north of Manchester, and this station is really too loud for the 'phones. Liverpool, Leeds, Bradford, London, Glasgow and Cardiff are the only B.B.C. stations I have yet picked up. I have only had the set one week. Radio-Paris, Brussels, Hamburg and another German station not known have been heard.

I think it is an excellent one-valve receiver, and I strongly recommend it to readers who wish to have a simple valve set.—Yours faithfully,

G. M. WILD.
Rochdale.

NEUTRALISING ACID

SIR,—Your contributor in the December 31 issue gives one the impression that French chalk will effectively neutralise weak sulphuric acid, which is hardly the case.

This substance usually consists of a magnesium silicate, and is nowhere nearly so effective as chalk (carbonate of lime).

After many years' experience of manufacturing sulphuric and other acids on a commercial scale I should for preference use weak ammonia (1 part household ammonia and 3 to 5 parts water) for all such purposes, especially on clothing and carpets.

In case one's hands become covered with sulphuric acid, it is usually best to wash them at once in a copious supply of cold running water and then to wash in weak ammonia or weak washing soda (carbonate of soda) solution. If burns have been received, carefully dry and then put on carron oil or some such remedy.

This applies mostly to fairly concentrated acid; the usual battery acid is easily got rid of by washing the hands in running water and then well lathering with soap, which usually contains sufficient alkali to effectively neutralise the acid.—Yours faithfully,

CHEMRADIO.
Timperley.

We are advised that the Dubilier Condenser Co., Ltd., have now moved to Victoria Road, North Acton, London, W.3.

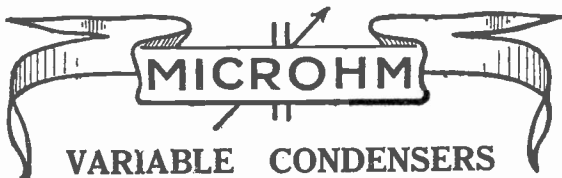

Obviate the disadvantages of complicated capacity variation.

The Microhm Variable Condenser—a precision instrument of great efficiency—has been scientifically designed to overcome the disadvantages of the open-vane type. The question of the moving vanes varying in their distance from other parts of the set and thus setting up a complicated form of capacity variation is rendered negligible in our model by the fixed electrodes which entirely enclose the vanes. Other advantages include:—No interaction, No Hand-capacity effects, Extremely low minimum capacity Ratio 500-1, Single hole $\frac{3}{8}$ " fixing, compact and dustproof.

PRICES:—"C" Type. To give straight capacity curve.
.0001—7/6. .00025—7/6. .0005—7/6.
.00075—8/6. .001—8/6.

"W" Type—Square Law Principle—1/- extra on above prices.

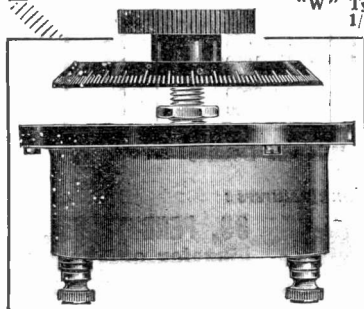

Fit a Microhm Variable Condenser to your set. You will speedily appreciate the difference.

Obtainable at most dealers or direct from the

Microhm Engineering Co.
Varsity Works;
COLLEGE ST., LONDON, E.9.

Phone: Clissold 2887.

Barclays 604.

Wireless Constructor

6D MONTHLY

EDITED BY PERCY W. HARRIS

Creating a Market

The "WIRELESS CONSTRUCTOR" has amply fulfilled its mission in Wireless. A new demand has been created from a large section of the public not previously catered for. This is amply proved by the fact that the "Wireless Constructor" has a circulation greater than that of all non-Radio Press wireless publications added together. It is, therefore, only pointing out the obvious to claim that your advertisement should also be included in its columns. Write for rates to the Advertisement Managers:—

Barclays Advertising, Ltd.,
Advertising Consultants & Contractors,
Bash House, Strand, London, W.C.2
Telephone: City 9911 (Extn. 9).

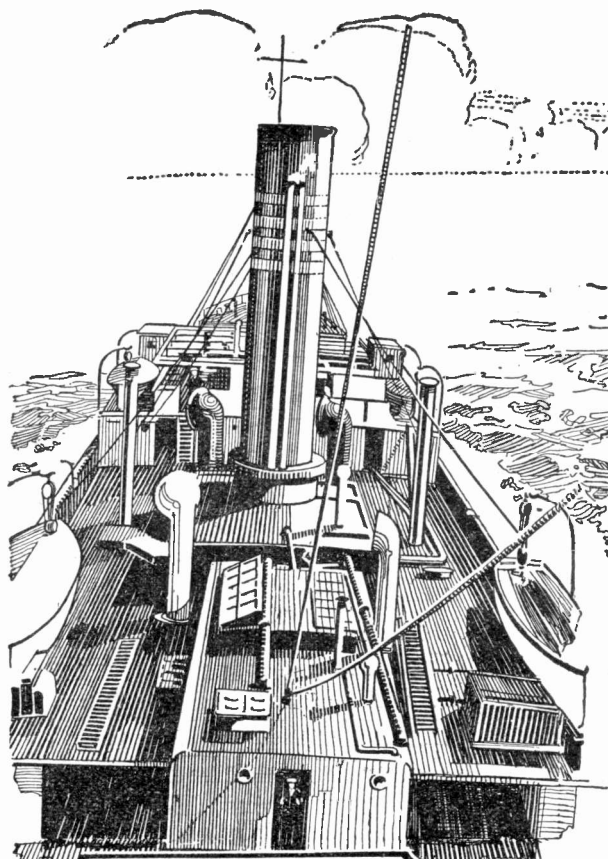

“Act as judgment says is proper”

THE “rule of the road” at sea calls upon the officer in charge of the ship in the foreground to “act as judgment says is proper” in avoiding collision with the approaching vessel.

To be able to form sound judgment and act on it promptly is one of the essential qualities of the sailor; and whether one is driving a car, playing billiards, or catching the morning train good judgment is equally necessary.

Consider the components you fit to your wireless set.

Upon them depends not only the success of the whole set but also your reputation as a wireless expert.

Your judgment tells you that if you choose the products of a firm which has a long specialised experience and a reputation for “making a sound engineering job of things” you will have chosen wisely and well.

It is a mistake to suppose that one make of condenser is much the same as another, and it is a mistake to believe that your set can give the best results if your condensers and resistances are of the just-as-good variety.

Act as judgment says is proper—

Specify Dubilier.

“If to my Starboard
 ..red appear,
 It is my duty to keep
 ..clear
 To act as judgment
 ..says is proper
 To Port or Starboard.
 Back or Stop her-”

A rule of the road for preventing collision at sea.



Ducon Works, Victoria Road, North Acton, London, W.3.

E.P.S.89

It will pay you always to watch WIRELESS WEEKLY Advertisements.

EXPERIMENTERS ALL THE WORLD OVER ARE USING POLAR

VARIABLE CONDENSERS AND FOR A VERY GOOD REASON!

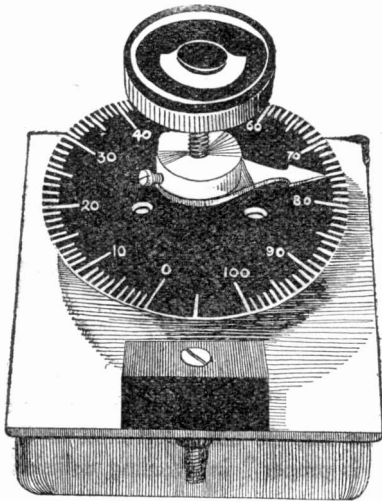

POLAR VARIABLE CONDENSER

All capacities.
.001, .0005, .0003, .00025 and
.0002 microfarad
are one size, 3" x 3" x 1"
One Price - 10/6

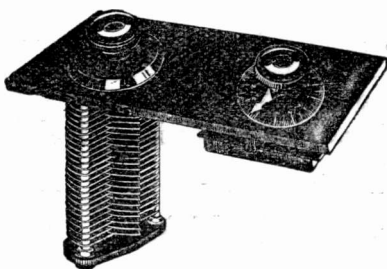

A .001 POLAR VARIABLE CONDENSER

mounted side by side with an air
condenser of the same capacity.

A few years ago Radio Communication Company were confronted by a very important question of providing their Marine Operators with a condenser which would give a wide open scale over the lower limits of tuning, and which would not require an additional micrometer condenser in parallel.

It is well known that in a tuned oscillatory circuit one should use as much inductance and as little capacity as possible.

The ordinary vane condenser could not be utilised, as most of its capacity is cramped over the lower section of the scale, with the result that a small knob adjustment will give a large capacity change when it is not wanted.

In order to obtain a high efficiency of tuning and to meet the exacting demands of marine work, a condenser had to be designed which would reverse the above effect and give the operator a wide open scale at the business end of the condenser.

After a good deal of research and numerous exacting tests, the Polar Variable Condenser was produced.

The secret of its popularity lies in the fact that a wide open scale giving a uniform variation of wave frequency is combined with wide capacity limits, high insulation, complete metallic screening, robust construction and small overall dimensions. (See illustration, which shows a Polar Condenser mounted side by side with an air condenser of the same capacity.)

WARNING.

Imitations of the Polar Condenser are now on the market, but, like most imitations, they fall far short of the genuine article from an efficiency point of view.

WHEN BUYING A CONDENSER INSIST ON SEEING THE NAME "POLAR" ON THE CARTON AND ON THE CONDENSER.

RADIO COMMUNICATION Co., Ltd., 34-35, Norfolk St., Strand, W.C.2

It will pay you always to watch WIRELESS WEEKLY Advertisements.



Apparatus we have tested

Conducted by A. D. COWPER, M.Sc., Staff Editor.

"Klutch" Terminal

Messrs. Henry Joseph & Co., Ltd., have sent for our inspection a sample of an easy-release terminal, the "Klutch." This is a small device of brass that, we understand, can also be obtained with a nickel finish, which holds a telephone tag or connecting wire in a light (but electrically effective) grasp between the cheeks of a spring clip. A slight tug on the wire, such as that made by an absent-minded listener who has forgotten the headphones and their attachments, will release it instantly from the terminal and obviate a disaster. For rapid changes of wiring in experimental work there are also obvious applications.

The device was found to operate as indicated, and gave good, firm connections that could be immediately released, with 'phone-tags of different sizes, spade-terminals, and ordinary connecting wires of fair gauge. The terminal would accommodate more than one 'phone-tag at a time. It can be held by the ordinary type of screw terminal, or secured directly on the panel by a No. 4 B.A. screw.

Edison Swan Headphones

Messrs. the Edison Swan Electric Co., Ltd., have sent for test a pair of their No. WL. 535 type headphones. These are of 4,000 ohms resistance, have double headbands and aluminium-cased receivers and are of light weight.

The usual type of swivel-adjustment fitting is provided. A cord of generous length is supplied with the 'phones. On trial, these were found to be far more free from discomfort after lengthy use than is usual with this type of head-band fitting, and the 'phones were of most commendable sensitiveness, a marked improvement in signal strength being noticed in changing over to these from other types repeatedly and alternately when receiving distant stations. The general finish and workmanship were of the highest class.

Combined Valve-Holder and Rheostat for Vertical Panel-Mounting

Home-constructors who favour the compact American type of re-

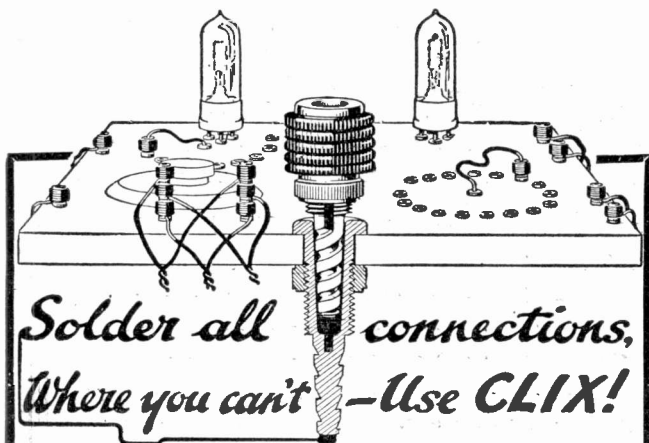

Solder all connections, Where you can't - Use CLIX!

CLIX PROVIDES AN IDEAL POINT FOR SOLDERING

- Retail Prices—
- CLIX with Locknut 3d.
 - CLIX Insulators (6 colours) 1d. each
 - CLIX Bushes (6 colours) 1d. pair

Obtainable from all Wireless Dealers or direct from the Patentees & Manufacturers:

Perfect contact—instantaneously—everywhere.

The tapered design of CLIX plugsocket ensures full surface contact in every one of its countless applications.

That's why CLIX, the Electro-link with 159 uses, supersedes all forms of Plugs, Terminals and Switches, and has standardised the wiring of all radio circuits.

AUTOVEYORS, LTD

Radio Engineers and Contractors

84 VICTORIA STREET, LONDON, S.W.1

CABINET AND PANEL WORK A SPECIALITY.

Non-standard Cabinets and Panels to Customers' designs produced at short notice.

We supply Cabinets, drilled and engraved Panels and any Components for all Radio Press Receivers. Send 2d. stamp for our new 100-page Catalogue and descriptive Leaflets.

Examples:—	Cabinet.	Panel.
4-Valve T.A.T.	27/-	24/9
Transatlantic "Four"	30/6	14/-
3-Valve Dual	40/6	20/-
Extra for carriage and packing on post orders	1/6	1/3

Large cabinets sent per rail carriage forward.

All Cabinets are best-seasoned walnut, hand-made and polished. Panels are guaranteed electrically, matt non-metallic finish, edges squared, accurately drilled and engraved.

RADION Panels supplied if desired at slight extra cost.

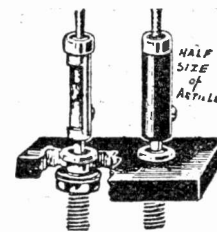

S.A.C. "Tapa" Plug and Socket Terminals

"the gadget of a thousand uses," in red or black and five other colours. "Once used always used." 6d. each. Sample pair free to all Clients ordering Panels or Cabinets.

S.A.C. Fireside Plug.

The last word in comfort and efficiency, for plugging in distant headphones, loud speakers, etc. 2/6 each.

Plug and Socket Terminals.

Our London Office is in a central position: we welcome inspection of our Cabinets and Panels.

"S. A. CUTTERS,"
15, Red Lion Square, London, W.C.1.

'Phone: Chancery 8042.

ceiver with vertical panel and with the valves concealed behind the panel, will find their constructional work much facilitated by a very neat form of combined valve-holder and filament resistance, the "Macitone Valvestat," a sample of which has reached us from H. Clough & Co. (Bacup), Ltd. This device is adapted for installing behind a vertical panel actually by the familiar one-hole fixing method with bush and large back-nut. The moulded former carrying the resistance-spiral (of usual type) has a bracket-extension which provides a valve-socket, in which the valve is inserted vertically and close behind the panel, above the resistance. If placed at the lower edge of the panel the base of the valve would come about 3 in. above the floor of the cabinet. Connection is already made to the one-valve socket for L.T. supply; the other sockets, and the input point to the filament resistance, are equipped with small tinned soldering tags for connections. A neat knob and bevel dial are provided for outside control; a small circular opal window enables the temperature of the filament to be observed.

The filament resistance is of the flat spiral type, and is provided with a spring contact-finger, secured by a substantial set-screw, which on

trial gave smooth and silent contact. The resistance was around 7 ohms maximum; positive stops and "off" position are provided. The insulation of the valve-holder on severe D.C. voltage test proved excellent. For those who are interested in compact designs, and who do not mind the task of soldering connections, this instrument can be strongly recommended.

Auxiliary Resistors for D.E. Valves

Lissen, Ltd., have submitted for test samples of their "Lissenstat Resistors" for addition to existing sets and to filament-resistances designed for use with ordinary bright-emitter valves, so as to make them available for use with the extremely low-consumption .06 type of dull-emitter valve.

These resistors consist of a small disc-former, 1-in. diameter, with a bushed centre-hole to fit over the existing L.T. terminal. In the samples submitted the hole was not quite No. 4 B.A. size, so that they required reamering out a trifle to fit on ordinary No. 4 B.A. terminals. A short side-arm carries a small terminal with soldering tag for more permanent connections. On the shank of this terminal is pivoted a contact finger, which makes contact with the turns of a spiral fine-wire resistance wound, in an exceed-

ingly neat manner, as a tiny basket-coil enclosed in the disc-former between insulating cheeks. The resistance can, accordingly, be varied conveniently over the whole range in spite of the small size of the fitting and compact design.

On test, the effective resistance was found to be about the 30 ohms which are required in such a case, and this could be varied at will by means of the contact finger. When installed in addition to the usual 5-7 ohms resistance, the latter acts as a fine adjustment in the most convenient manner.

The little device can certainly be recommended for those who desire to advance to the modern D.E. valve, or who wish to mix their valves on the same multi-valve receiver.

"Ledion" Crystal

Messrs. Ledion, Ltd., have sent for trial a sample of their "Ledion" crystal. This is a bright, coarsely-crystalline galena of fairly uniform appearance, which is not unduly brittle on fracture to obtain fresh surfaces. On trial, it showed the usual proportion of sensitive spots and quantitative rectification powers on a uniform transmission, associated with a good galena. It is packed in small sealed boxes.

"Here, just listen to this
-I've never before had such fine reception!"



You can share this lucky fellow's enthusiasm when you have tried a "Uralium" Crystal on your set.

"Uralium" is a natural product, and the finest thing in the way of wireless crystals that has ever been discovered.

You naturally want the best reception your set is capable of. Well, there is one way to get it.

Use—

Uralium
 NATURE'S WONDER CRYSTAL

"Uralium" is put up in neat little boxes with a silver cat's-whisker. The price is 1/6.

USE ONE
 AND BECOME
 A
 URALIMUM
 ENTHUSIAST

Obtainable of all Dealers or direct from
BOWER ELECTRIC LIMITED,
 15, Grape Street, Shaftesbury Avenue, LONDON.
SCOTLAND. Messrs. THOMPSON & BROWN BROS.,
 Ltd., 118, George Street, Edinburgh.
 Aberdeen: 13, Bon Accord Street.
 Glasgow: 65, Mitchell Street.
 Dundee: 2a, King Street.
LANCASHIRE AND CHESHIRE.
 HENRY HOLLINGBAKE & SON, Ltd., Wireless
 Factors, Princess Street, Stockport.
LEEDS. T. B. MORLEY & CO., 67, Basinghall St., Leeds.
NEWCASTLE-ON-TYNE. Messrs. PAYNE & HORNSBY,
 Ltd., 6/7, St. Andrew's Buildings, Gallowgate,
 Newcastle-on-Tyne.
NOTTINGHAM. Messrs. PAYNE & HORNSBY, Ltd.,
 Stoney Street, Nottingham.
BELFAST. Messrs. PAYNE & HORNSBY, Ltd., Castle
 Street, Belfast.



DUBILIER PRODUCTS

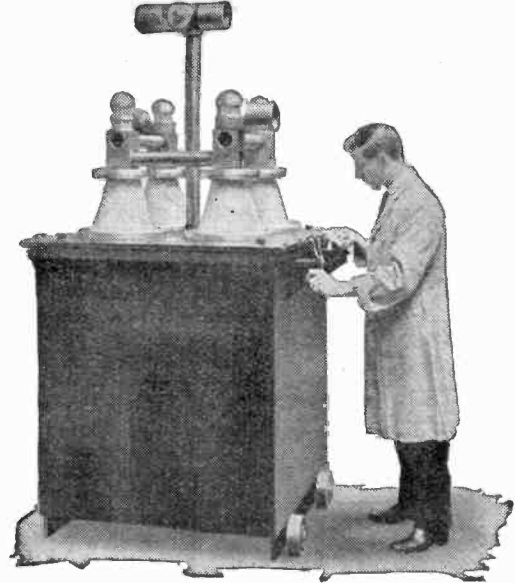
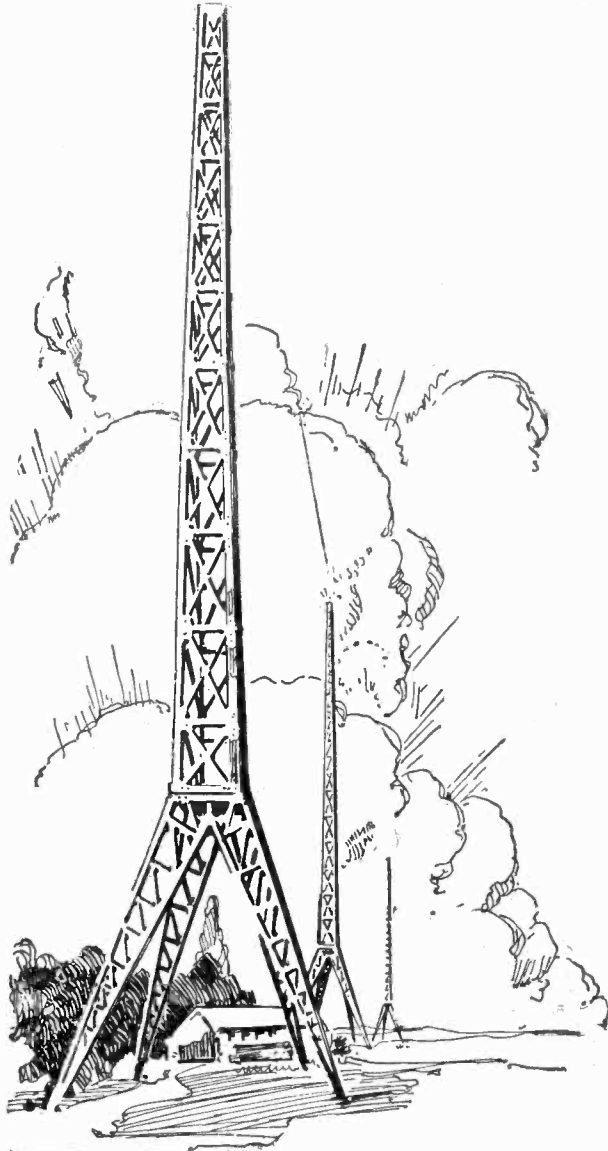

THE condenser shown above is one unit of a bank of ten made by us to carry **820 amps. at 32,000 volts.**

These condensers are tested by us for 8 hours on full load, and, in addition, at 68,000 volts for ten minutes.

Similar high power condensers are constantly being manufactured at our works and supplied to the leading wireless stations of the world.

There is only one standard of Dubilier workmanship and the small fixed condensers intended for your wireless set receive the same careful attention as their high power counterparts.

Both have to uphold the Dubilier reputation.

Always Specify Dubilier Condensers.

Ducon Works,
Victoria Road,
North Acton,
London, W.3.



DUBILIER CONDENSER CO. LTD

Telephone:
Chiswick 2241.

Telegrams:
Hivoltcon, Phone,
London.

It will pay you always to watch WIRELESS WEEKLY Advertisements.

(E.P.S. 122)

Silvertown

WIRELESS ACCESSORIES.

Quality guaranteed by over 50 years' electrical manufacturing experience.

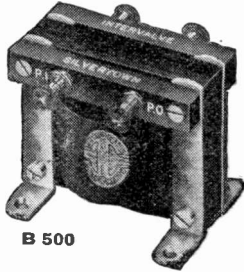

B 500

INTERVAL TRANSFORMERS.

Adopted by leading manufacturers of Wireless Receiving Sets and discriminating Amateurs in all parts of the world. Guaranteed for 12 months. Price 21/- each.



FILAMENT RHEOSTATS.

With finished and lacquered brass bush for panel mounting. Resistance wire wound on insulating rod, thereby giving perfectly smooth adjustment. Each supplied with diagram giving drilling dimensions. 3/6 each.

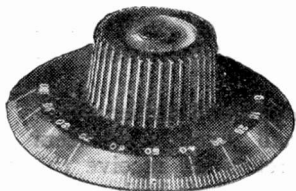

EBONITE CONDENSER DIALS AND KNOBS.

In one piece, graduated in white 0.1800, highly finished, complete with fixing screw, dial approximately 3 in. diameter. Complete 1/3 each. Dials only, 10d. each.

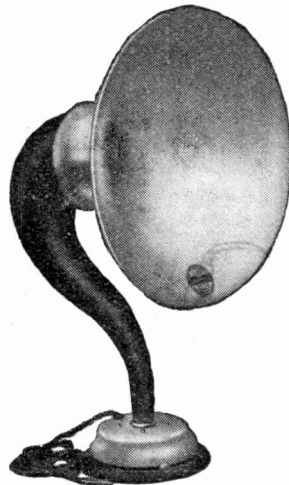

SILVERVOX LOUD SPEAKER

This instrument will reproduce both speech and music without the loss of its original tone and quality. Coils wound to either 120 or 2,000 ohms.

The tone arm is a heavy aluminium casting.

Excellent strengths can be obtained on an efficient 2-valve receiver within 10 miles of broadcasting station.

Total height, 20 inches. Size of trumpet, 12½ inches diameter.

PRICE £3 10s. EACH

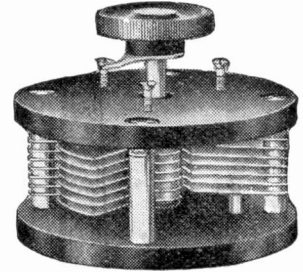

VARIABLE CONDENSERS.
(For panel mounting.)

Strongly constructed. Moving vanes are shaped to give low minimum capacity. Fitted with a stop to allow of a movement of 1800 only. From 5/6 each.

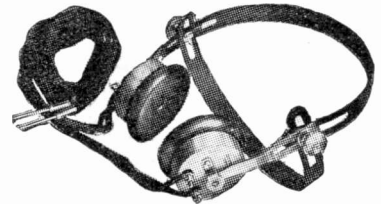

TELEPHONE HEADPIECES.

The "Stalloy" diaphragms are matched so as to secure a balance of tone and quality. Resistance from 120 to 12,000 ohms. Price (4,000 ohms) 25/- each.

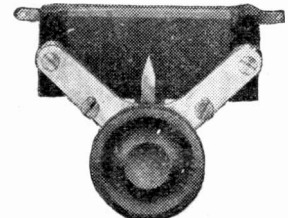

POTENTIOMETERS.
(For panel mounting.)

On rectangular ebonite former, complete with knob and pointer. Former mounted on cast brass frame. Resistance approximately 400 ohms. 7/6 each.

Makers:— THE SILVERTOWN COMPANY,

106, Cannon Street, London, E.C.4.

Works: Silvertown, London, E.16.

- BELFAST: 75, Ann Street.
- BIRMINGHAM: 15, Martineau Street.
- BRISTOL: 4, Victoria Street.
- CARDIFF: Pier Head Chambers, Bute Docks.
- DUBLIN: 70, Middle Abbey Street.
- GLASGOW: 15, Royal Exchange Square.
- LEEDS: 1, New York Road.



- LIVERPOOL: 54, Castle Street.
- LONDON: 100 and 102, Cannon Street.
- MANCHESTER: 16, John Dalton Street.
- NEWCASTLE-ON-TYNE: 59, Westgate Road.
- PORTSMOUTH: 49, High Street.
- SHEFFIELD: 88-90, Queen Street.

It will pay you always to watch WIRELESS WEEKLY Advertisements.

Information Department

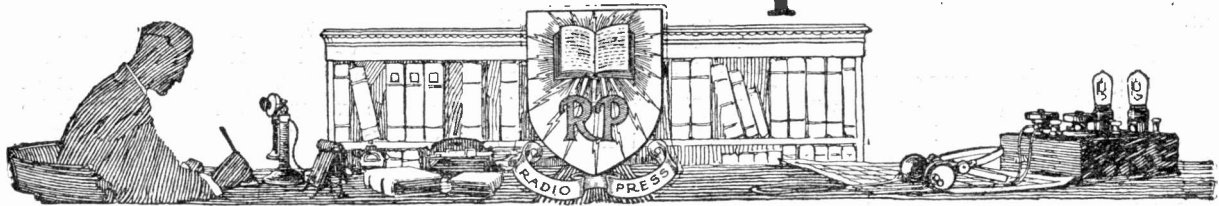

SUPPLIED BY RADIO PRESS SERVICE DEPT., LTD.

A. F. E. (KINGSTON) wishes to insert a Marconiphone Ideal low-frequency transformer in his receiver, and is somewhat puzzled as to the correct ratio to employ.

The design of this transformer is such that with a general purpose valve the low-ratio type should be used immediately following the detector, this being the one of 2.7 to 1 ratio. We would suggest that for your second low-frequency valve, viz., the one in the anode circuit of which the loud-speaker is connected, you should use a small power valve, and in this case the second low-frequency transformer should be of the higher ratio, the one of intermediate ratio being suitable.

B. M. A. (HULL) submits details of his aerial system, and asks for criticisms, in view of the fact that he is unable to receive stations other than the local relay.

Our correspondent's sketch shows that the end of the aerial from which the down lead is taken is supported by a short pole attached to the gable end of the house, at a height of 29 ft. from the ground, while the free end is taken to the roof of a summer house where it is only 11 ft. from the ground. This is generally regarded as a most inefficient arrangement, and the first step which should be taken is the raising of the free end to a height at least equal to that of the house end.

With regard to the material of which the aerial is constructed, it seems to us that the wire (No. 22. bare copper) is rather on the thin side, and it would be worth while to substitute the conventional 7/22 enamelled copper or phosphor bronze wire.

We observe that our correspondent has only one very small insulator at each end of the aerial, and that these are of some moulded material, whose insulating efficiency may be open to suspicion. We therefore suggest that at least two good porcelain insulators be fitted at each end of the aerial, and that attention should be paid to the leading-in point. It should be remembered in this connection that most insulating materials of the nature



Three in One

Check your wavelengths, calibrate coils and transformers, and cut out interfering stations all with this single instrument, the Bowyer-Lowe Mark 1 Wavemeter. Every experimenter will find it invaluable.

The instrument is mounted on Ebonite and fitted in polished Mahogany case. Each wavemeter individually calibrated and supplied with full instructions
price ... £4:4:0

Send for Our First Complete Catalogue

containing 36 pages of information about our trustworthy components with blanks for your own notes. Sent post free for your name and address with 1/3d. stamp to cover packing, etc. Get it to-day.

Bowyer-Lowe Tested Radio Components

BOWYER-LOWE Co., Ltd., LETCHWORTH.

Quality RADIO BASKET COIL HOLDERS

Basket Coils are undoubtedly one of the most efficient forms of compact inductance for short waves.

If you make your own, or buy them ready made, you need good holders for the best results. The **BASKET COIL HOLDERS** are efficient **Quality RADIO** in design, manufactured from the best British materials and finished in an unsurpassed style. Made from the best British ebonite (not fibre), brass parts polished and lacquered and polished knob.



No illustration can do them justice. The price is so reasonable—

1/3 EACH

Postage 2d.

that you can fit one to every coil.

This is the original **BASKET COIL HOLDER** of its type, all good dealers stock them but insist on seeing the trade mark stamped on each one. All others are inferior copies. Each packed in transparent envelope.



If your dealer has not got them we send post free if you mention his name and address. LIST POST FREE.

GOSWELL ENGINEERING CO., LTD.,
12a, PENTONVILLE ROAD, LONDON, N.1.
LIBERAL TRADE TERMS. 'Phone 1 North 3051.

of ebonite are prone to deteriorate when exposed to the atmosphere of a town, and surface leakage of quite a considerable amount will result.

A. J. Q. (KILMACANOGUE) is using a resistance capacity low frequency amplifier and is having considerable difficulty in removing the trouble known as "choking." He finds that if he increases the value of his high tension supply about 50 volts, signals become distorted and the set ultimately chokes up in such a way that signals practically disappear. Upon investigation with a milliammeter in the plate circuit of the valve, he finds that the first symptom is a considerable rise in the plate current upon increase of the high tension value, followed by a fall as the choking out process takes place.

It appears from our correspondent's letter that he is using Dutch valves of a type which we believe to be the soft rectifying variety, and if this is so, the symptoms which he describes are perfectly natural, and we fear can be removed only by the use of a more suitable type of valve. Such

valves are entirely unsuited to resistance capacity amplification.

W. I. R. (CRIGGLESTONE) asks our views regarding the soldering of connections to the ends of grid leaks of the cartridge type.

This certainly does not seem to be a very desirable practice, and we think it should not be done unless it proves impossible to adopt any other method of making connection to the grid leak. No doubt, if a really hot iron is used and the joint very quickly and cleanly made, it is quite possible to make the connection without injury to the grid leak, but unless the constructor possesses a good deal of skill with the soldering iron, this is by no means easy. Any experimenter, therefore, who has not full confidence in his soldering powers should rather use separate pairs of clips mounted directly upon the panel in those cases where he cannot place the grid leak directly in the clips of the condenser. Incidentally, we believe that clips of the type which are fitted to Dubilier condensers can now be obtained separately, and one of these may be used to support one end of the grid leak, the other end

being gripped in one of the clips of the grid condenser itself.

E. T. U. (EASINGWOLD) asks our advice in view of the fact that he has had repeated experiences of the burning out of all three of the valves in his set, although he uses only a 6-volt accumulator and turns the filament rheostat to the minimum position at all times. The valves were ordinary bright emitters of a standard make.

The first step which our correspondent should undoubtedly take is to return the valves to the makers, and ask them whether there is any chance of the valves themselves being defective, and if the answer is in the negative, as we think it will be, in view of the number of failures, attention should be turned to the filament resistances, which may quite possibly be of a pattern which is occasionally met with wherein the resistance element is of so low a value that even when turned to the minimum current position little reduction is produced in the voltage applied to the valve, and consequently if almost the full 6 volts are applied to a 4-volt valve a short life is inevitable.

BRETWOOD PATENT VALVE HOLDER.

Eliminate poor reception by adopting this scientifically designed Valve Holder, and obtain 100 per cent. efficiency. Easy to fix. No capacity. No leakage. Always perfect contact. No soldering. Can be mounted on front or back of Panel. Price 1/9. Postage 3d

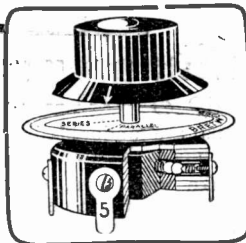

beautifully smooth action, made possible by the spring loaded balls, and the wiping of rolling motion of the Phosphor-Bronze Balls always ensures clean and perfect electrical contact. Features: 1. Absolute freedom from capacity. 2. Perfect contact. 3. Sweet and smooth action. 4. Practically no wear-and-tear. 5. First-class finish and neat in appearance. 6. Easy to fix (one hole fixing). 7. Very easy to make wire connections. 8. Like our other components, it is fully guaranteed. 9. For value offered, the price is moderate.

RADIO IMPROVEMENTS, LTD., 12-18, London Mews, Maple Street, LONDON, W.
All Bretwood specialities are obtainable from most Wireless Dealers.

ANTI-CAPACITY SWITCH.

We have pleasure in presenting another first-class speciality which is the outcome of the famous **BRETWOOD ANTI-CAPACITY VALVE HOLDER**, which has gained such popularity among the wireless public on account of its scientific design and smart appearance. The **Bretwood Switch** is constructed on similar lines, and we claim that it is, like the Valve Holder, absolutely free from capacity effects, and we feel confident that this component will meet with the most exacting requirements of the present day experimenter. One of the principal features of the Bretwood Switch is its beautifully smooth action, made possible by the spring loaded balls, and the wiping of rolling motion of the Phosphor-Bronze Balls always ensures clean and perfect electrical contact. Features: 1. Absolute freedom from capacity. 2. Perfect contact. 3. Sweet and smooth action. 4. Practically no wear-and-tear. 5. First-class finish and neat in appearance. 6. Easy to fix (one hole fixing). 7. Very easy to make wire connections. 8. Like our other components, it is fully guaranteed. 9. For value offered, the price is moderate.

Price 5/-
Postage 3d.

It's THE LEAK that Counts.



The Bretwood Grid Leak (Guaranteed) tunes a carrier wave from the silent point up. The Bretwood is recognised by highest experts and experimenters as the only variable and reliable Grid Leak.

Price 3/-
Postage 3d.
Patent Pending.

Barclays 632

EBONITE

Sheet rod and tubing in all sizes kept in stock and cut to any required size while you wait, or sent by post on receipt of cash.

WE CAN TURN ANYTHING IN EBONITE.

BURGE, WARREN & RIDGLEY, LTD.,

91/92, GREAT SAFFRON HILL, LONDON, E.C.1. 'Phone: Holborn 50

EL-BE UTILITIES The "MIKROTUNE"

Makes Tuning Simple & Certain.

Reversible Coil-holder. Adds 50% value to any set. **12/6**

Coils under minutest control. A PERFECT VARIOMETER. Send us the name of your Dealer and we will arrange a demonstration for you.

LEIGH BROS. 37, SIDMOUTH ST., GRAY'S INN ROAD, LONDON W.C.1. Telephone: Museum 4192

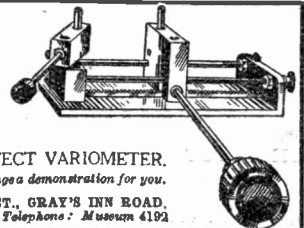

Patents, Designs and Trade Marks

H. D. FITZPATRICK & Co.,

Chartered Patent Agents,

49, CHANCERY LANE, LONDON.

Phone: HOLB. 459.

Radio Press Information Dept.

2/6 QUERY COUPON 2/6

WIRELESS WEEKLY. Vol. 5. No. 13. January 14, 1925. This coupon must be accompanied by a postal order of 2/6 for each question, and a stamped addressed envelope.

Louden Valves



Filament Volts - 4.8-5
 Filament Amps. 0.4
 Anode Volts - 40-80

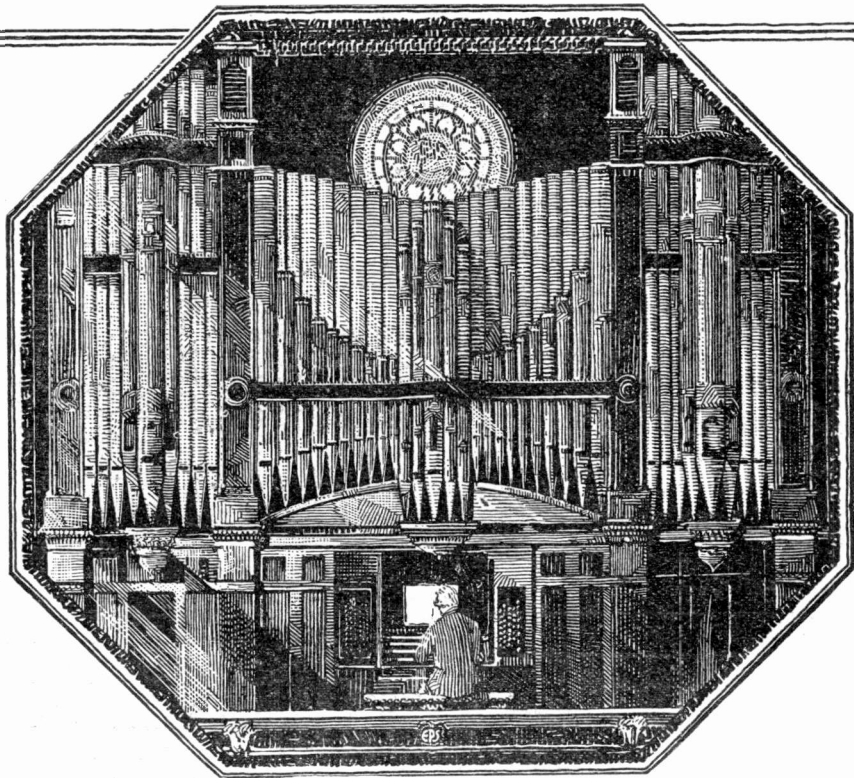

"There let the pealing organ blow."—Milton.

The organ is undoubtedly the most noble of all musical instruments, and at the same time the most versatile.

In the hands of a true artist the instrument lends itself to an almost infinite variety of expression and imitation.

The clear notes of the diapason, the shrill notes of the flute, the pure harmonies of stringed instruments, and even the liquid tones of the human voice can all be reproduced with a faithfulness that is almost startling in its reality.

It seems unfortunate, therefore, that the organ should be the most difficult of all musical instruments to transmit by wireless.

So if you hope to receive clearly the lovely music of the organ you must take all precautions at your end. And the first precaution of all is to use Louden Valves.

Louden Valves are absolutely free from distortion and all unwanted noises. It is this outstanding quality of Silver-Clearness which is mainly responsible for their amazingly rapid popularity.

For the listener-in, however interested he may occasionally be in distant stations, is chiefly concerned with clear reproduction. And this is precisely what the Silver-Clear Louden gives him, and will give you as well, without having to go to any large expense. For the Louden only costs 10/-. Try one to-day.

The Plain Louden for Detecting and Low Frequency Amplifying.

The Blue Louden for H.F. Amplification.

All Loudens are Silver Clear and free from mush. Their current consumption is very low and their life long.

Price 10/-

Louden Valves - Silver Clear



ADVT. OF THE FELLOWS MAGNETO CO., LTD., PARK ROYAL, LONDON, N.W., 20
 E.P.S. 40



Books by JOHN SCOTT-TAGGART, F.Inst.P., A.M.I.E.E.

The total sales of books by this author have reached approximately half a million. This success has been attained by consistent accuracy, originality, and a very real sympathy for the experimenter and the man who "wants to know more." Under his direction, the three papers of the Radio Press have achieved outstanding success, and this is largely due to an instinct for realising what the wireless man wants to know, and then giving him the information in an accurate, lucid and thoroughly interesting manner.

The *Daily Express*, in its issue of November 5th, 1924, says:

"British wireless engineers, however, are not in the least degree behind those of any other country in the world in developing radio receivers.

"Among the British experts who are keeping the British radio flag flying is Mr. J. Scott-Taggart, the energetic editor of several popular technical journals. It is doubtful if any other one person—unless perhaps Captain Round, of the Marconi Company—has been responsible for more original radio circuits and ideas than has Mr. Scott-Taggart."



<i>Series</i>	<i>Series</i>
No. 1 Wireless For All ... 9d.	No. 9 Wireless Valves Simply Explained 2/6
No. 2 Simplified Wireless ... 1/-	No. 10 Practical Wireless Valve Circuits 2/6
No. 3 How to Make Your Own Broadcast Receiver ... 1/6	No. 12 Radio Valves and How to Use Them 2/6
Radio Press Envelope No. 1 (ST.100 Receiver) 1/6	No. 15 More Practical Valve Circuits ... 3/6
	Elementary Textbook on Wireless Vacuum Tubes ... 10/-
	Thermionic Tubes in Radio Telegraphy and Telephony (2nd Edition) ... 15/-

All these are obtainable from booksellers and wireless dealers or direct (plus 2d. postage on books and 3d. on the envelope) from (Book Dept. S.) **RADIO PRESS LTD.**, the largest wireless publishers in the world, **BUSH HOUSE, STRAND, LONDON, W.C.2.**

Barclays. 100r.

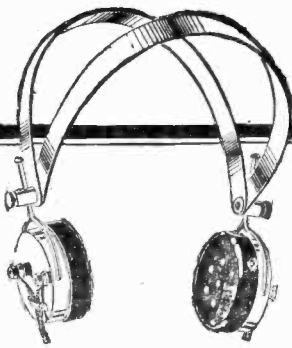

They weigh but six ounces!

OBVIOUSLY tele-phones for Broadcast use should be light in weight, sensitive and low in cost.

The Brown Featherweight Headphone is probably the lightest in the world (including cords it weighs but 6 ounces) yet its sensitiveness compares favourably with others considerably heavier.

And Broadcast enthusiasts fully appreciate that at twenty-five shillings the pair these Featherweights have no competitor.

Thoroughly well made, under typical Brown supervision, they are indeed remarkable value for money.

From all Dealers:

4000 ohms 25/-

also 120 ohms 22/6

Handphones (4000 ohms) 33/-

S. G. BROWN LIMITED
Victoria Road, N. Acton, W.3

Showrooms:

19 MORTIMER STREET, W.1
15 MOORFIELDS, LIVERPOOL
67 HIGH ST., SOUTHAMPTON

Brown
Wireless Apparatus

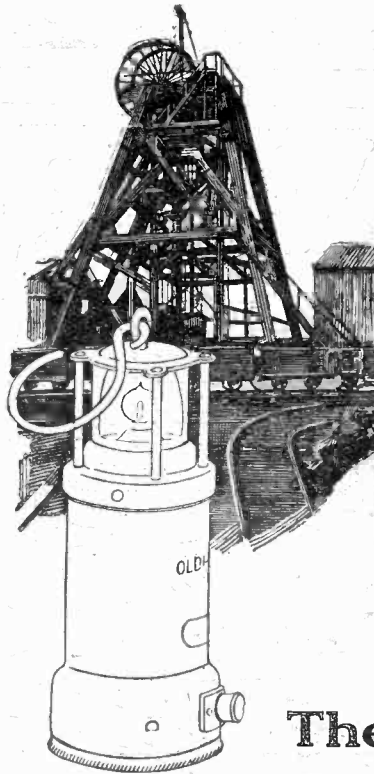

Dealers. Write to-day for particulars of the Oldham proposition.

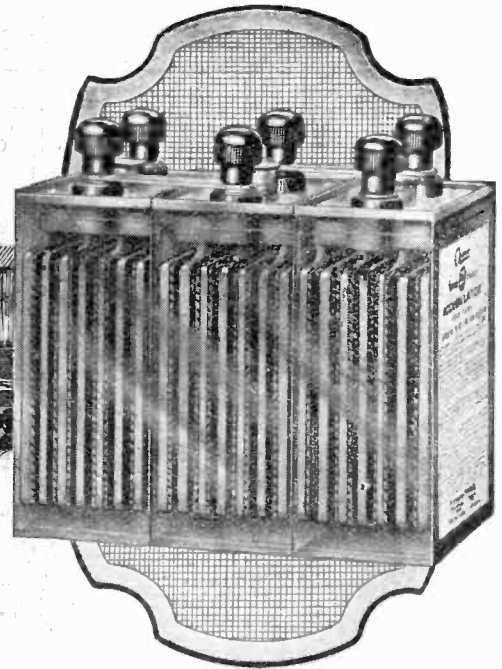

The miner wants dependability—
so do you.

OF all the conditions under which an accumulator must operate—surely the most exacting is in the Coal-mine. Here—in the Oldham Miner's Lamp—is a small accumulator, limited in size and weight and which must function for its allotted eight hours and more. Apart from charging intervals it must be in constant use month in and month out for a very extended period. A breakdown below ground might endanger life and limb, besides creating a loss of confidence on the part of the men working below.

Obviously, therefore, the accumulator in the Oldham Miner's Lamp must be the very last word in reliability. In their search for improvements the makers of the Oldham Accumulator evolved the special activation process—a method of plate manufacture which is responsible for remarkable improvements in life and output.

Remember the same qualities that are so much sought for in an accumulator below ground are also essential for Radio use—long life, greater capacity, absolute dependability.

To be certain of getting these advantages your Accumulator must be an Oldham—the only one manufactured under the special activation process.

From all Dealers at prices no higher than those charged for the ordinary type of Accumulators.

Sole Manufacturers:
Oldham & Son, Ltd.
Denton, Manchester.

London Office:
Great Chapel Street,
Oxford Street, W.1.

Special Activation Process
OLDHAM
ACCUMULATORS



3 SOUND MEDIA

When compiling your Advertising campaign, do not overlook the claims of the three predominant media in radio: viz., MODERN WIRELESS, WIRELESS WEEKLY and THE WIRELESS CONSTRUCTOR. You cannot afford to ignore the responsive public that eagerly and consistently studies the pages of these journals and which constitutes an excellent established market for your goods.

MODERN WIRELESS, WIRELESS WEEKLY and THE WIRELESS CONSTRUCTOR readers embrace the huge section ranging from the youthful broadcast receiver experimenter, and the amateur inventor to the highest expert in Wireless, and the greatest confidence is placed in the practical hints, diagrams and constructional notes repeatedly appearing in the columns of these journals written by men whose names are "household" words in the world of radio. Such a specialised and interested community cannot fail to elicit the maximum response to your appeal.

Write now for advertisement rates and details of forthcoming issues to the Advertisement Managers:—

BARCLAYS ADVERTISING LTD.
 Advertising Agents, Consultants & Contractors,
BUSH HOUSE, STRAND, LONDON, W.C.2

Telephone: CITY 9911.

The Media in Wireless Journalism

which constitute a complete and efficient Advertising Campaign for Selling Sets, Components or Accessories.

REGISTERED

REPAIRS
 TO HEADPHONES
 TO LOUD SPEAKERS
 TO COILS
 Est. 26 years
Rewound to any Resistance and made equal to new. Price quoted on receipt of instruments.
Prompt Delivery.
The VARLEY MAGNET Company
 WOOLWICH, S.E.18.
 Phone: Woolwich 888.

CABINETS YOU WANT
PICKETT'S Insulated Cabinets = for 100% results. From 1/6 each, highly polished.
 All designs and sizes

"MADE for CONSTRUCTORS."
Write now for Constructors' Lists Free.
PICKETT'S Cabinet (W.L.) Works, Bexleyheath, S.E.

BARCLAYS SERVICE

The experience of the Principal and staff of this Agency is such that their advice and assistance, freely given to wireless manufacturers and retailers, is accepted as sound, accurate in every detail and of proven value.

The Manager has been intimately associated with wireless and advertising from the days when there was only one public wireless periodical in this country. He is well known to the trade generally and has chosen a staff of experienced men, each of whom, in his own sphere, is able to solidify the complete service rendered by the agency.

Representatives, copy writers, artists and lay-out men are all in close touch with every aspect of wireless sales promotion. The results of their co-operation is fully in keeping with the following extract from a letter just received:—

"We regret to have to inform you that this business has grown so rapidly during the last month (thanks to the wonderful result of your advertisements), that we have been quite unable to keep pace with our orders."

Why not take advantage of this accumulated experience and knowledge of present day methods so essential to the expansion of your business.

Consultations Free by appointment.
BARCLAYS ADVERTISING Ltd.
 Advertising Consultants and Contractors,
Bush House, Strand, London, W.C.2
 Telephone: City 9911 (Extn. 9).



No. 3 of Series.

The Living Artistes

THERE is no greater test for a Transformer than Loud Speaker reproduction of a Symphony Concert. Delicate arias and impressive crescendos mean a wide range in amplification valves that will readily discover any integral weakness of design.

For a transformer to be capable of amplifying all frequencies equally—from the shrill notes of the piccolo to the boom of the double bass—necessitates the application of scientific laws. The Eureka Concert Grand owing to its exclusive design does amplify all audible frequencies equally—that is why in the reproduction of a Symphony Concert you will not hear the violins stressed to the exclusion of the flute or the oboe. In fact, when the Concert Grand is used in conjunction with a good Loud Speaker, each Instrument can be readily picked out and identified. How very few L.F. Transformers will permit this being done. Music lovers throughout the country have been quick to recognise that the Eureka has set an entirely new standard of tone perfection. If your present Set is not giving you satisfaction, remove the L.F. Transformers and substitute a pair of Eureka's. You'll then know how well it really can perform unhampered by unsuitable and inefficient components,

Concert Grand 30/- Portable Utilities Co., Ltd., Eureka No. 2 22/6
 Fisher Street, London, W.C.1. (For Second Stage)

Supreme **EUREKA** for Tone

Give your set "that professional look!"



TO BE KEPT PERFECTLY FLAT.

RADIO PRESS
Wireless Panel
Transfers

6°

The most complete set of
Transfers on the Market.

—Empress— your own panel and give your set a distinctive appearance. The process is so simple in the use of a child's transfer and the general effect is extremely pleasing.

This transfer contains 88 different labels including a large number space transfer. See all the transfers in "WIRELESS WEEKLY" and "ROBERT'S WIRELESS". These transfers are of Radio Press quality and are supplied in a 10/625 or other in a guarantee.

INSTRUCTIONS

When the label is used and it will with a pair of scissors, carefully remove the transfer from the soft paper backing and place on, pressing on the plastic paper. A hot iron, such as a Radio Press of which does so, should be used to heat the plastic paper to the back of the transfer. All the transfers are a few moments' waiting. The transfer adheres to the cabinet and it is a snap to use to arrange the labels upon which other transfers of the same kind are required.

Approved by
Radio Press Ltd.
15, Abchurch Lane,
LONDON, E.C. 4.

IT'S the little things that count, and for sixpence you can give your set that professional look, by using "Radio Press Wireless Panel Transfers" (sold in large packets of 80 labels). They make all the difference and add finish to your Panel. The Radio Press use them on their own sets, which is in itself proof that they are the best—they are also the cheapest.

Buy a packet or two from your local wireless dealer, or bookseller, but be sure you get what you want.

"Radio Press" Wireless Panel Transfers,
6d. per packet or 8d. post free direct from

Radio Press, Ltd.

BUSH HOUSE, STRAND, LONDON, W.C.2.

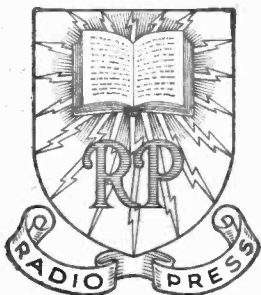

THE BOOKS for Beginners and Experts

The Radio Press Series.

No.		Price
1	Wireless for All ... By John Scott-Taggart, F.Inst.P., A.M.I.E.E.	9d.
2	Simplified Wireless ... By John Scott-Taggart, F.Inst.P., A.M.I.E.E.	1/-
3	How to Make Your Own Broadcast Receiver ... By John Scott-Taggart, F.Inst.P., A.M.I.E.E.	1/6
4	How to Erect Your Wireless Aerial... By B. Mitchell, A.M.I.E.E.	1/-
5	The Construction of Wireless Receiving Apparatus ... By P. D. Tyers.	1/6
6	The Construction of Crystal Receivers ... By Alan L. M. Douglas.	1/6
7	How to Make a "Unit" Wireless Receiver ... By E. Redpath.	2/6
8	Pictorial Wireless Circuits ... By Oswald J. Rankin.	1/6
9	Wireless Valves Simply Explained... By John Scott-Taggart, F.Inst.P., A.M.I.E.E.	2/6
10	Practical Wireless Valve Circuits ... By John Scott-Taggart, F.Inst.P., A.M.I.E.E.	2/6
12	Radio Valves and How to Use Them By John Scott-Taggart, F.Inst.P., A.M.I.E.E.	2/6
13	500 Wireless Questions Answered ... By G. P. Kendall, B.Sc., & E. Redpath.	2/6
14	12 Tested Wireless Sets ... By Percy W. Harris, Member I.R.E.	2/6
15	More Practical Valve Circuits ... By John Scott-Taggart, F.Inst.P., A.M.I.E.E.	3/6
16	Home-Built Wireless Components ...	2/6
17	Wireless Sets for Home Constructors By E. Redpath.	2/6
18	Tuning Coils and How to Wind Them By G. P. Kendall, B.Sc.	1/6

RADIO PRESS PANEL CARDS.

1	How to Make the W.I. Receiver ... By Herbert K. Simpson.	1/-
---	---	-----

SIMPLEX WIRING CHARTS.

1	For 2-Valve Set ...	1/-
2	For 3-Valve Set ...	1/-
3	For 4-Valve Set ...	1/-

RADIO PRESS WIRELESS PANEL TRANSFERS ... 6d.

* MODERN WIRELESS COIL TABLE for Aerial, Ano and Re-action Coils ... 6d.

RADIO PRESS ENVELOPES.

1	How to Build an S.T.100 Receiver ... By John Scott-Taggart, F.Inst.P., A.M.I.E.E.	1/6
2	How to Build a 4-Valve Receiver ... By Percy W. Harris, Member I.R.E.	2/6
3	How to Build the "Simplicity" 3-Valve Set. By G. P. Kendall, B.Sc.	2/6
4	How to Build the All-Concert-de-Luxe Receiver. ... By Percy W. Harris, Member I.R.E.	2/6
8	How to Make a 1-Valve Reflex Receiver. By Herbert K. Simpson ...	1/6
9	How to Build an Efficient Single- Valve Set. By Herbert K. Simpson...	1/6

The Radio Press Envelopes are the most complete guide to wireless construction ever devised. They contain exact size panel and wiring blue prints, complete working drawings, sheets of instructions regarding construction and working lists of components, and many photographs on beautiful art paper showing the set and wiring from every possible angle. Every possible detail is explained and you cannot go wrong.

* Just published.

Any of the above publications can be obtained from principal wireless dealers and through any bookseller—or direct (plus 2d. postage, or, on Radio Press Envelopes 3d.) from Book Dept. S,

RADIO PRESS LTD.
BUSH HOUSE, STRAND,
LONDON, W.C.2.

Barclays Ad.

Quality and Distinction

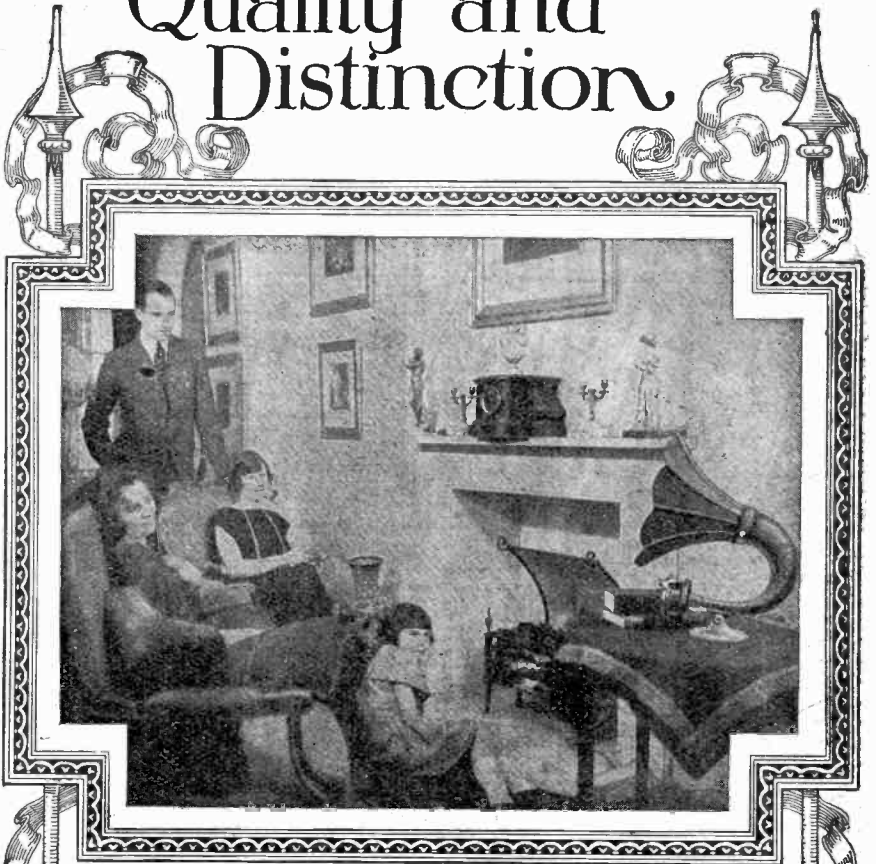

THE remarkable clarity and delightfully natural Tone of the World-famous **AMPLION** Loud Speaker when associated with a suitable Receiving Set render wireless reproduction comparable with the original performance.

With an **AMPLION** the unseen speaker, vocalist or orchestra, as the case may be, is brought right into the Home and the advantages of Radio Broadcast may be enjoyed to the very full.

In artistry of design and fine finish the **AMPLION** excels just as its efficiency is unapproached, so that the **AMPLION** may well be regarded as the one and only Wireless Loud Speaker for the Home of Beauty and Refinement.

Write for illustrated folder describing **AMPLION** Models—from 25/- upwards—obtainable from all Wireless dealers of repute.

The World's Standard **AMPLION** Wireless Loud Speaker

A Product of The House of Graham

Patentees and Manufacturers:
ALFRED GRAHAM & CO. (E. A. GRAHAM),
St. Andrew's Works, Crofton Park, London, S.E.4.

It will pay you always to watch WIRELESS WEEKLY Advertisements.

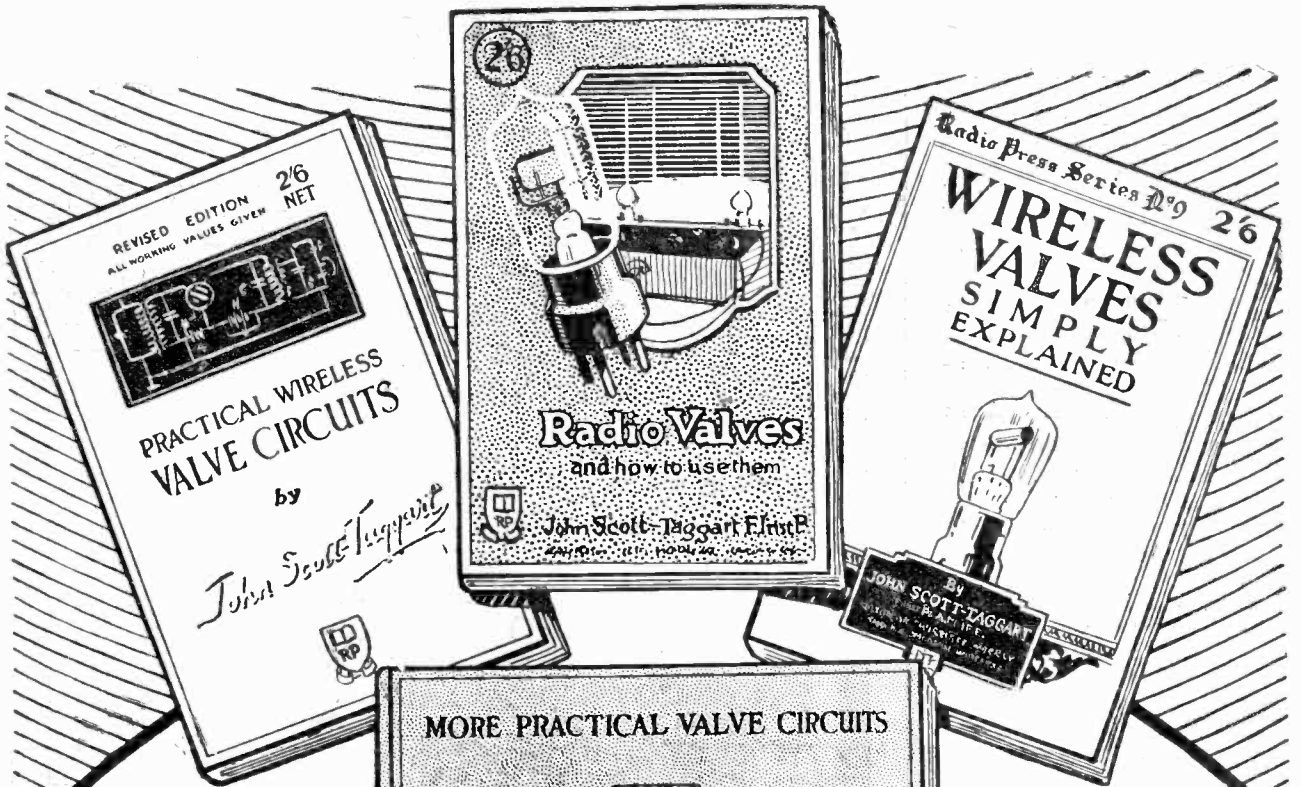

YOU NEED THESE BOOKS

Practical Wireless Valve Circuits

Series No. S 10.

This is the first book of ST circuits and is called **Practical Wireless Valve Circuits**, by John Scott-Taggart, F.Inst.P., A.M.I.E.E. Price 2/6 (post free 2/8). Circuits ST 1 to ST 67 are published in this book, which is selling as well to-day as when it was published. No experimenter worthy of the name can afford to be without the two ST Circuit Books. They are friends which will never lead you astray. Each circuit in both books is fully described and criticised.

All component valves are given in the new editions of **Practical Wireless Valve Circuits** and **More Practical Valve Circuits**.

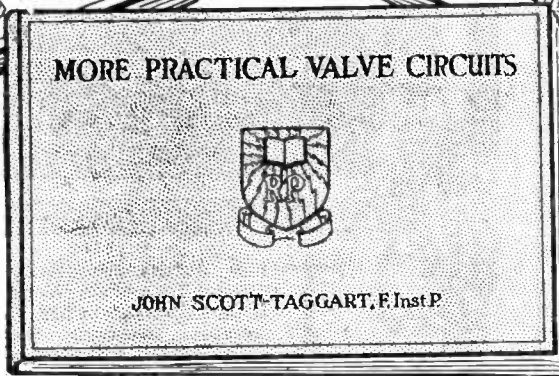

"S.T." Circuits

These are too well known to need any introduction. This is the latest book of them:—

More Practical Valve Circuits

Series No. S 15.

By JOHN SCOTT-TAGGART, F.Inst.P., A.M.I.E.E.
Price 3/6 (post free 3/8).

Full of dozens of original circuits which you will find nowhere else, as they are copyright. Circuits ST 68 to 141 and also ST 150 and 151 appear in this extremely useful volume, which has had an enormous sale amongst experimenters.

Radio Valves and How to Use Them

Series No. S 12.

Mr. Scott-Taggart has stated that he regards this as his best book on the Valve from the point of view of the beginner. **Radio Valves and How to Use Them**, by John Scott-Taggart, F.Inst.P., A.M.I.E.E. Price 2/6 (post free 2/8). This book is by far the largest published by Radio Press, Ltd., at 2/6, and is full of very valuable information. The reader is presumed to know only what is contained in our Books, "Wireless For All" and "Simplified Wireless."

YOU NEED THESE BOOKS

Wireless Valves Simply Explained

Series No. S 9.

By JOHN SCOTT-TAGGART, F.Inst.P., A.M.I.E.E.

The most popular moderately priced Book on the theory of Wireless yet written. It contains the results of many years' patient research and experiments—but told in a non-technical language which the amateur can easily understand.

How reaction is caused—how to stop self-oscillation—how to select suitable circuits for various purposes—how to receive C.W.—the answers to all these and many other questions are clearly given.

If you want to know how your set works this is the Book you need.

2/6 or 2/8 post free.

All Radio Press Books are obtainable from principal wireless dealers and through any bookseller, newsagent, or from Book Dept. S, Radio Press, Ltd.

Radio Press, Ltd.

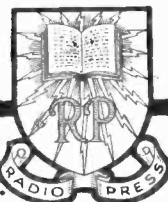

BUSH HOUSE, STRAND, LONDON, W.C.2

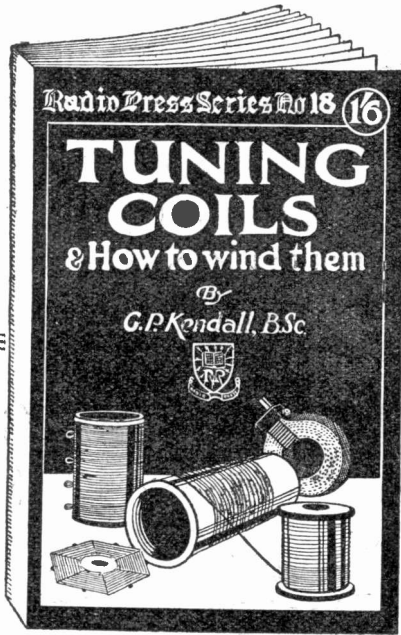

THERE is probably no single Component in any Receiving Set able to exert so much influence as an Inductance Coil. A highly efficient Coil (or Coils) will often make all the difference between mediocre results and really good loud reception.

Even if you feel that your present Set is giving tolerably good results, the chances are that it will be worth your while—presuming that you are using plug-in coils—for short-wave lengths to use a set of home-made basket coils. Such coils as these have particularly low self-capacity.

This new book by G. P. Kendall, B.Sc. (staff editor) contains concise details for making every type of Coil used in Wireless to-day. Further, the advantages and disadvantages of each type are discussed in such a manner that the reader is able to make an immediate decision as to the actual coils suitable for his requirements.

All necessary data, such as diameter of tubes, gauge of wire, number of turns, etc., are given—the results of the author's own experiments.

No experimenter can afford to be without such a comprehensive guide as this.

TUNING COILS AND HOW TO WIND THEM.

SERIES No. 18

1/6

Sold by all Booksellers, Newsagents, or through your local Wireless Dealer or 1/8 post free, direct from Department S,

Radio Press, Ltd.
BUSH HOUSE, STRAND, LONDON, W.C.2.

LATEST RECEIVING SETS

Radiax designs cover a series of most up-to-date Sets, which without undue complication include many refinements rarely included in any one set. Series, parallel condensers, valve switches, filament switches, fine tuning devices, etc., make Radiax suitable for long or short waves. In fact they are Universal. You may BUILD YOURSELF or BUY COMPLETE.

No. 61—2-VALVE REGENERATIVE

A really wonderful set, simple to handle, but sharply tuned, it will give good Loud Speaker results up to about 20/25 miles, and will also pick up most British and Continental Stations.

Including pair of Broadcast Coils, £4 15 0
(Supplied as factory completed set only.)
With Valves, Batteries, and Accessories, including a first class make of Loud Speaker. £10 0 0



No. 61.

THE UNIVERSAL SERIES

These are real "distant" sets with one High Frequency Amplifier, and whether you buy complete or build up yourself from our constructor's set, it is an outfit you will be proud to possess.

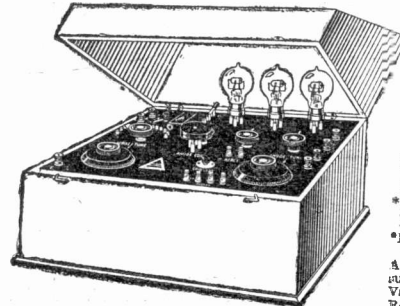

No.	Set.	£ s. d.	Factory Constructor's completed and tested.	£ s. d.
24.	2-Valve	4 15 0		6 12 6
26.	3 "	7 5 0		10 17 6
*28.	4 "	9 15 0		15 0 0
30.	4 "	9 7 6		15 0 0

*No. 28 has double circuit serial tuning with 3-coil holder.

All above sets subject 12/6 per Valve Maroon Royalty.

RADIAX, LTD., 50, Radio House, Percy St., Tottenham Court Rd., LONDON, W.1.
3 minutes Tottenham Court Road and Goadge Street Tube Stations.



WIRELESS CABINETS

IN VARIOUS DESIGNS, and WOODS
Mahogany. Satin Walnut. White Wood polished Mahogany.

Enquiries Invited.

Delivery from Stock.

Catalogue Post Free

Specials to Order.

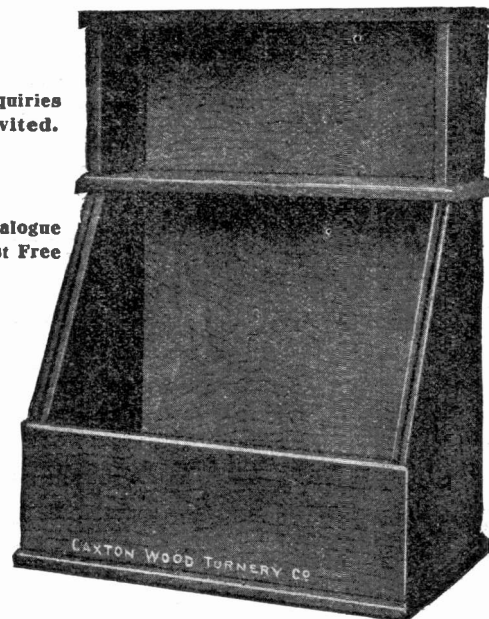

Makers: CAXTON CABINET & WOOD TURNERY MILLS
MARKET HARBOROUGH.

Telegrams & Telephone: Haddon, 59, Market Harborough

It will pay you always to watch WIRELESS WEEKLY Advertisements.



*Build one of these Fine
Simpson Single Valve Sets*

RADIO PRESS envelopes contain all the information necessary to enable anyone to construct highly efficient wireless apparatus even if they have no previous technical or practical experience. Each envelope contains all necessary working drawings, instruction sheets, full sized blue prints and photographs.

Radio Press
Envelope No. 9
.
.
.
SIMPSON
Single Valve
Set
1s. 6d.
(Post free 1s. 9d.)

Envelope No. 9 enables you to make the splendid single valve set illustrated above. It has been designed by Herbert K. Simpson, and dozens of letters have testified to its range and power.

Envelope No. 8 enables you to make a one valve Reflex Receiver as illustrated below. Works a loud speaker up to 10 miles from a Broadcasting Station, strong phone signals up to 50 mile.

Radio Press
Envelope No. 8
.
.
.
SIMPSON
One Valve
Reflex Receiver
1s. 6d.
(Post free 1s. 9d.)

Obtainable from booksellers and wireless dealers or direct from Dept., S.
Radio Press, Ltd.
The largest Wireless Publishers in the world,
Bush House, Strand, London, W.C.2.

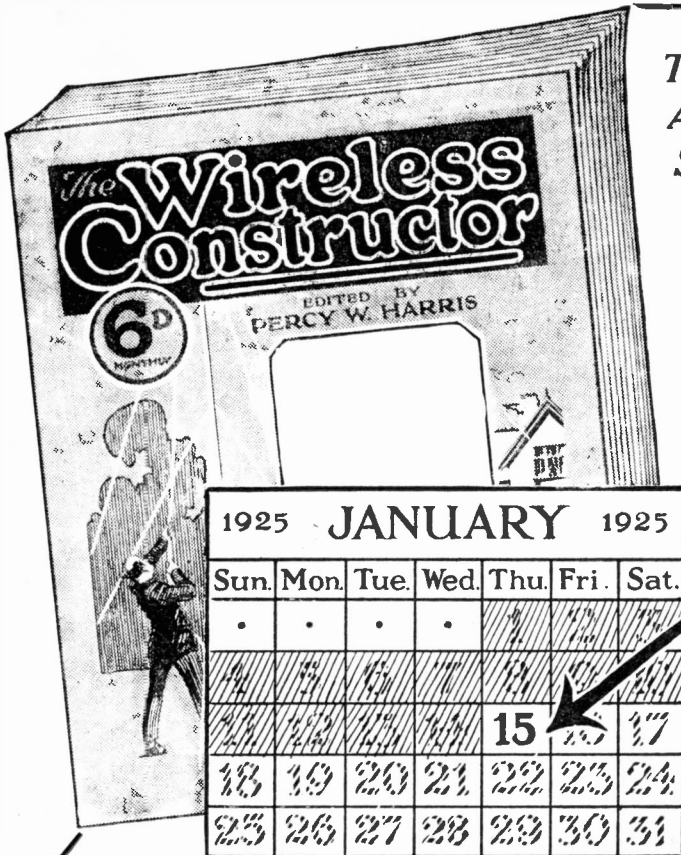

**THE MAGAZINE THAT EVERY
ADVANCED WIRELESS MAN
STRONGLY RECOMMENDS TO
HIS LESS EXPERIENCED
FRIENDS**

Over a quarter of a million wireless enthusiasts have found that the WIRELESS CONSTRUCTOR is the Monthly Magazine which they have been waiting for. This issue offers greater attractions than any of the previous numbers. It presents page after page of fascinating information, interesting articles and useful notes, written in such a clear and lucid manner that even the most inexperienced will not find himself out of his depth. The issue now

On Sale

abounds with numerous designs, splendid illustrations and diagrams drawn in such a way that you simply cannot go wrong, even if you have never seen a wireless diagram before. Full of sound advice, hints and tips, any item of which may possibly save you shillings, or even pounds when designing or building a set, yet the cost of this magazine, with the largest circulation of any in England, is only Sixpence. Regular readers will find that they obtain a progressive course of wireless which will enable them to appreciate more fully the enormous possibilities for future pleasure and entertainment in which their friends can join them.

Get Your Copy To-day.

Selection from Contents :

- HOW TO BUILD A COMPACT SINGLE VALVE REFLEX RECEIVER.
By Percy W. Harris, Member I.R.E.
 - THE ROLLS-ROYCE OF RADIO.
(How the Superheterodyne works.)
By John Scott-Taggart, F.Inst.P., A.M.I.E.E.
 - THE ANGLO-AMERICAN SIX (Contd.).
By Percy W. Harris, Member I.R.E.
 - HOW TO GET THE BEST OUT OF A CRYSTAL SET.
By G. P. Kendall, B.Sc.
 - A LOW-LOSS CRYSTAL RECEIVER.
By Percy W. Harris, Member I.R.E.
 - SIX SIMPLE CRYSTAL CIRCUITS.
 - HOW TO TUNE A SIMPLE VALVE SET.
By Stanley G. Rattee, Member, I.R.E.
 - THE HUMOURS OF MR. GUMBLE-THORPE.
- and many more articles of interest.
- FREE BLUE PRINT
with every copy.**

Any reader of the WIRELESS CONSTRUCTOR can build any one of the sets described with confidence. Provided he follows the instructions given, his success is guaranteed by the Radio Press.

The WIRELESS CONSTRUCTOR is edited by Percy W. Harris, Member I.R.E., who is the best-known and most able constructional writer in the country. The way clear and concise explanations of otherwise difficult problems flow from his facile pen has gained the admiration of beginner and expert alike.

When writing constructional articles, Percy Harris, Member I.R.E., never overlooks the fact that the average reader has not a large assortment of tools to hand, therefore, a beginner can generally build a set described at lowest possible cost.

All Radio Press Publications

are under the general and personal direction of John Scott-Taggart, F.Inst.P., A.M.I.E.E., the well-known authority and inventor of the S.T.100 and many other original and popular circuits.

The **Wireless
Constructor**
(6d. monthly)

Obtainable from all Bookstalls Newsagents and Booksellers, or
8s. 6d. per annum post free.

Radio Press, Ltd., Bush House, Strand, London, W.C.2.

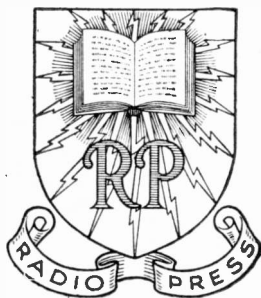

Insulation

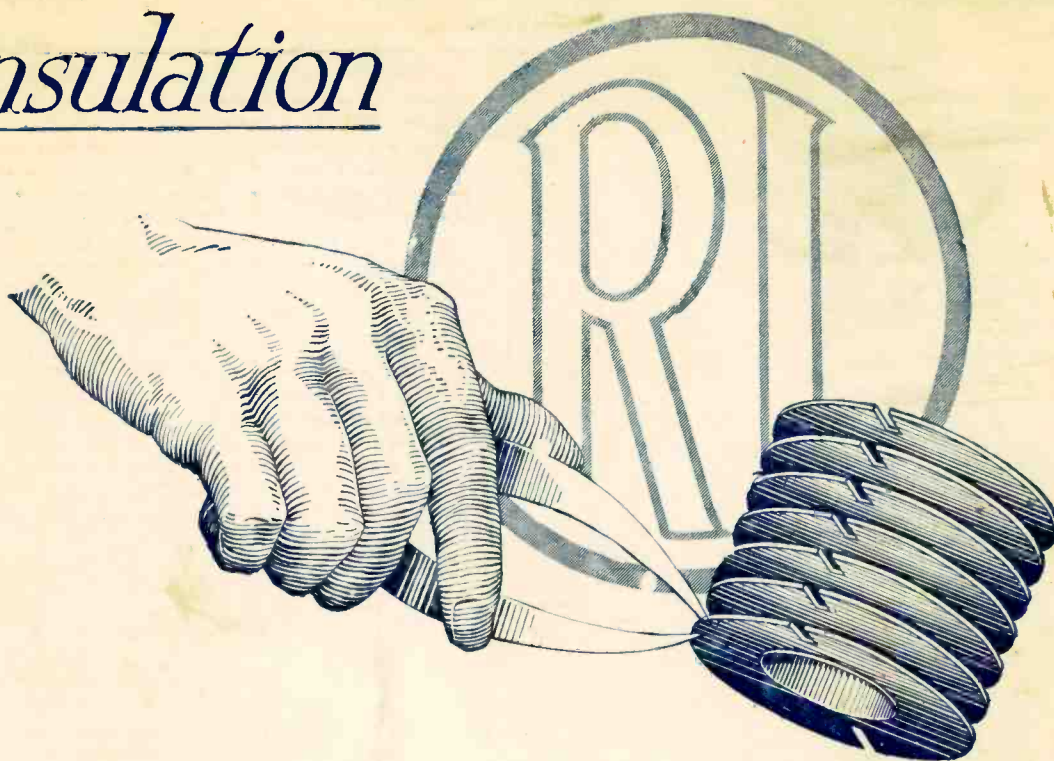

HERE is another feature of the World's Transformer that emphasises
THE CONSTRUCTION THAT COUNTS.

Note the heavy walls of insulation that separate the sections of both primary and secondary windings. Each compartment is electrically fortified against breakdown or leakage, and the ratio of insulation to wire in this construction is greater than that of any other transformer on the market, giving as a result the remarkably low **SELF CAPACITY of only 18 micro-microfarads.** In addition, the sectionalising of the winding results in a distribution of the voltage which greatly reduces the possibility of breakdown.

We can afford to guarantee R.I. productions. Their design and workmanship is so splendidly strong in construction and results that the possibility of failure is reduced to a minimum. Thousands have found the claims of the R.I. to be genuine. You must make sure of

MAXIMUM VOLUME—MINIMUM DISTORTION

by demanding an R.I.

Price **25/-**

Ask for the new R.I. Brochure.



Radio Instruments Ltd.
 12 Hycle Street, Oxford Street

Telephone: REGENT 6214 (5 lines) W.C.I. Telegrams: Instradio London